

PROFINET Field Devices

Recommendations for Design and Implementation

Contents

1 Motivation	1
2 Organization	1
2.1 PROFIBUS & PROFINET International (PI)	1
2.2 How do I become a member of PROFIBUS & PROFINET International? ..	1
2.3 How do I get a PROFINET VendorID?	2
2.4 Where do I get technical support?	2
2.4.1 Technology partners	2
2.4.2 Competence Centers	2
2.4.3 Test Labs	2
2.5 Is device certification required?	2
3 Components of PROFINET field device development	2
3.1 Which topics must be considered?	2
3.1.1 Customer requirements	2
3.1.2 PROFINET field device	3
3.1.3 Device description file	3
3.1.4 Certification	3
3.1.5 Life cycle	3
3.2 Chronological sequence of field device development	3
4 Start of development of a PROFINET field device	4
4.1 What device model does PROFINET use?	4
4.2 Modular or compact field device?	5
4.3 What is the diagnostics concept of PROFINET?	5
4.4 I&M	5
4.4.1 What does I&M mean?	5
4.4.2 What does AMR mean?	6
4.4.3 What are the advantages of I&M and AMR?	6
4.5 When is IRT required?	6
4.5.1 IRT - Isochronous communication	6
4.5.2 Isochronous applications	7
4.5.3 When should a field device support IRT? ..	7
4.6 Where is time-of-day synchronization required?	7
4.6.1 Time-of-day synchronization and Sequence of Events (SoE)	7
4.6.2 What time-of-day synchronization does PROFINET use?	8
4.6.3 What is the difference between cycle synchronization and time-of-day synchronization?	8
4.6.4 What must be considered for implementation?	8
4.7 When are gateways appropriate?	8
4.8 Requirements for specific industry sectors (automobile manufacturers, process industry, etc.)	9
4.9 From PROFIBUS to PROFINET	9
4.9.1 Modularity	9
4.9.2 Provider / consumer principle	9
4.9.3 IO data	9
4.9.4 Startup following a configuration difference	9
4.9.5 Diagnostics	10
4.9.6 I&M	10
4.9.7 VendorID	10
4.9.8 More than 240 bytes of acyclic data	10
4.9.9 Transfer of configuration	10
4.9.10 The head station	10
5 Mechanics	10
5.1 Are there special requirements for housings and connectors?	10
5.2 Which cables does PROFINET use?	10
5.2.1 PROFINET copper cabling	10
5.2.2 PROFINET fiber-optic cabling	11
5.3 Which plug connectors are available for PROFINET?	11
5.3.1 RJ45 plug connector for copper cable ..	11
5.3.2 M12 plug connector for copper cable ..	13
5.3.3 Plug connectors for fiber-optic cable ..	13
5.3.4 Plug connectors of type BFOC and SC for FOC	13
5.3.5 Signal plug connector	13

5.4 What need to be considered for device integration of connectors and sockets?	13	6.6.3 How do I make the GSD available to my customers?	21
5.5 What needs to be noted for electromagnetic compatibility (EMC)? ..	14	6.7 Tools	21
5.5.1 Grounding and shielding concept for PROFINET	14	6.7.1 What tool can I use to check a GSD?	21
5.5.2 Connecting cable shields	15	6.7.2 Which tools are used to create a GSD?	21
5.5.3 Functional grounding	16	6.8 Good practice	22
5.5.4 Functional grounding for devices with 24V supply	16	6.8.1 Creating the GSD	22
5.5.5 Protective grounding and functional grounding for devices with 230/400V supply	16	6.8.2 Checking the GSD	22
5.5.6 Functional grounding for M12 power supply connectors	16	7 Profiles	22
5.6 Should the MAC address be visible on the device?	17	7.1 What are profiles?	22
5.7 Do LEDs have to be incorporated?	17	7.1.1 What are the benefits of profiles?	23
5.7.1 Status LEDs	17	7.1.2 What profiles are available?	23
5.7.2 Link / Activity LEDs	17	7.2 PROFIsafe	23
6 GSD (General Station Description)	17	7.2.1 Where is PROFIsafe required?	23
6.1 What is a GSD?	17	7.2.2 What principle do PROFIsafe field devices use?	23
6.2 What is the GSDML (GSD Markup Language)?	18	7.2.3 What has to be considered for the implementation?	23
6.3 What information does the GSD file contain?	18	7.2.4 Where is implementation support available?	24
6.3.1 Profile Header	18	7.2.5 Safety assessment	24
6.3.2 Profile Body	18	7.3 PROFIdrive	25
6.4 What needs to be considered for the VendorID and DeviceID for the GSD? ..	18	7.3.1 Which drives does PROFIdrive use?	25
6.5 What effects does the application have on the GSD?	20	7.3.2 How is implementation carried out?	25
6.5.1 Conformance Classes (CC)	20	7.3.3 Where is implementation support available?	25
6.5.2 Application Classes (optional)	20	7.4 ENCODER profile	26
6.6 What should be considered for "Life Cycle Management" of the GSD? ..	20	7.4.1 Which encoders use the ENCODER profile?	26
6.6.1 What are the effects of changes to the GSDML?	20	7.4.2 How is implementation carried out?	26
6.6.2 Do further developments of the field device influence the GSD file?	20	7.5 PROFInergy	26
		7.5.1 How does PROFInergy function?	27
		7.5.2 What must be considered for the field device implementation?	27
		8 Stacks / Modules / Implementation	27
		8.1 General	27
		8.2 Technology Workshops	27

8.3	What benefits do modules offer?	27
8.4	Embedded solutions.....	28
8.4.1	Software solution with standard microcontroller	28
8.4.2	When are ASIC solutions of interest?	28
8.5	Which advantages do FPGAs offer?	29
9	Certification	29
9.1	Is certification required for PROFINET? ..	29
9.2	General procedure for obtaining a certificate	29
9.3	What does the manufacturer have to clarify or create for a certification?.....	29
9.4	Can I reuse the certificate of the technology provider?.....	30
9.5	References	30
10	Life Cycle of the PROFINET field device	30
10.1	Version numbers of the PROFINET field device	30
10.2	How do further developments of the field device influence the GSD file?	31
10.2.1	Scenario "New hardware variant: head station"	31
10.2.2	Scenario "new software with new PROFINET features for existing hardware".....	31
10.3	What should be considered for the delivery state of the field device?.....	31
11	Product marketing	31
11.1	The product catalog of PI	31
11.2	Presentation of field devices at trade fairs.....	32
11.3	Advertising of field devices in PROFINEWS	32
11.4	Marketing working groups.....	32
12	Glossary	V
13	References.....	VII

List of figures

Fig. 1:	Topics of PROFINET field device development.....	3	Fig. 19:	Interaction between GSD and engineering	19
Fig. 2:	Chronological sequence of PROFINET field device development	3	Fig. 20:	XML representation in the GSD Checker	21
Fig. 3:	Device model of a PROFINET field device.....	4	Fig. 21:	HTML representation in the GSD Checker	22
Fig. 4:	Roles of the I&M and AMR data.....	6	Fig. 22:	"Black Channel" principle.....	24
Fig. 5:	Schematic representation of an isochronous cycle.....	6	Fig. 23:	PROFIsafe-layers in F-host and F-device.....	24
Fig. 6:	Time-of-day segment synchronized via gPTP.....	7	Fig. 24:	PROFIdrive and Encoder application classes.....	25
Fig. 7:	Cross-section through an 8-wire PROFINET cable.....	11	Fig. 25:	PROFIdrive interface	26
Fig. 8:	RJ45 plug connector for copper cable	12	Fig. 26:	PROFInergy commands.....	27
Fig. 9:	M12 plug connector for copper cable	12	Fig. 27:	Field device with communication module.....	27
Fig. 10:	Plug connectors for fiber-optic cable	12	Fig. 28:	Field device with software solution ..	28
Fig. 11:	Signal plug connector.....	12	Fig. 29:	Field device with host CPU and simple ASIC/FPGA, application, and PROFINET stack on host CPU.....	28
Fig. 12:	Design rules for RJ45 Push-Pull connector type	13	Fig. 30:	Field device without host CPU with ASIC (SoC), application, and PROFINET stack on ASIC CPU	28
Fig. 13:	Design rules for SCRJ Push-Pull connector type	14	Fig. 31:	Field device with host CPU and ASIC (SoC), PROFINET stack on ASIC CPU, and application on host CPU ...	28
Fig. 14:	Multiport device.....	14	Fig. 32:	Multi-vendor wall of PI at trade fairs	32
Fig. 15:	Equipotential bonding and grounding.....	15	Fig. 33:	Individual company presentations at PI trade fair booth	32
Fig. 16:	4-core PROFINET cable.....	16			
Fig. 17:	GSD and engineering tool.....	18			
Fig. 18:	General part of a GSD in XML representation.....	19			

List of tables

Tab. 1:	Achievable transmission distance of FOC fiber types.....	11
---------	--	----

1 Motivation

"My customer would like PROFINET, but how do I do that?"

Development of a PROFINET device or addition of a PROFINET interface to an existing device - these are the tasks for which this guideline is intended. In addition, it contains advice and recommendations - all in the sense of a best practice approach. It makes no difference whether the reader already knows PROFINET or is totally new to the subject.

PROFINET is an established, flexible, and powerful industrial network based on IEEE 802 Standard Ethernet. PROFINET has established itself in recent years not only because of its openness but also due to its strengths. These include a powerful diagnostics model, the ability to coexist with Internet protocols on the same cable, and scalability of communication.

It's not a coincidence that there's so much performance. PROFINET is a sophisticated standard, and all disciplines involved must collaborate to develop a PROFINET device:

- Mechanics
- Hardware
- Software
- Project management
- Product management
- Marketing

This guideline addresses all of these disciplines and highlights what is important. It also tells you where you can find additional details on relevant subjects. It thus applies to everyone involved in development - no matter whether they work in different departments or whether all functions are executed in a multi-discipline role.

Fast, successful development is only possible when all aspects are taken into consideration.

With that in mind, we wish you success!

Information about this guideline

PROFIBUS & PROFINET International (PI) organization offers a large selection of PROFINET documents on its web page, including specifications and standards, system descriptions, guidelines, brochures and other technical descriptions. Marketing documents can be downloaded free of charge, while technical specifications and descriptions are available for free download by PI members only. The purpose of this guideline is to provide field device designers and manufacturers an overview of the PROFINET technology without the need to dive deep into

the many specifications and standards right away. Individual topics are briefly explained. For each topic, there are references to the underlying specifications and standards in case deeper understanding is needed or desired.

2 Organization

2.1 PROFIBUS & PROFINET International (PI)

PROFIBUS & PROFINET International is an organization with more than 1,400 members worldwide. Members include the leading automation companies, large users, universities, and many small and medium-sized companies.

The objective of the organization is the continuous further development of PROFIBUS and PROFINET technologies.

For detailed information about PROFIBUS & PROFINET International (PI), go to www.profibus.com.

2.2 How do I become a member of PROFIBUS & PROFINET International?

Membership is open to all companies, associations, and institutions that support the interests of PI as manufacturers, users, system vendors, or owners of PROFIBUS and PROFINET networks. Experts from different companies collaborate in various working groups to develop specifications. An application for membership can be made via any of the regional organizations. Links to the websites of the regional organizations, so-called "Regional PI Associations" (RPA), can be found by going to the PROFIBUS & PROFINET International home page.

In Germany for instance, the membership fee is based on type and size of company. Applications and other information regarding benefits of membership are available on the websites of the regional PI associations. For example, on the website of the PROFIBUS Nutzerorganisation e. V. (PNO) in Germany (www.profibus.de).

Membership is not essential for developing a PROFINET field device, but it offers numerous advantages. Members have free access to all technical documents, may use PROFINET patents free of charge, and may take advantage of marketing activities of their regional PI association (RPA) for promotion of their products.

2.3 How do I get a PROFINET VendorID?

PROFINET field devices must be uniquely identifiable in a system. For PROFINET, this is accomplished by the combination of VendorID and DeviceID. The VendorID is assigned by PROFIBUS & PROFINET International and is managed in a central list: (www.profibus.com/IM/Man_ID_Table.xml).

To request a VendorID, send an informal request to certification@profibus.com. For more information on this topic, see: www.profibus.com/support.

2.4 Where do I get technical support?

2.4.1 Technology partners

Technology partners typically collaborate on the specification, convert the basic specification into hardware and firmware for device development, and provide support for the realization of a PROFINET connection. These are globally active companies with many years of experience in industrial communication. Technology partners offer a variety of development services aimed at easing the burden on a company's own development resources. The offer includes hardware in the form of communication modules, ASICs, and FPGAs and software stacks for processing PROFINET communication, as well as technical support, consultation, and training.

For Germany, an overview of companies and their service offers can be found in the brochure "PROFINET Technology - The Easy Way to PROFINET", which is available as a free download (www.profibus.com/pntb).

Note: The approach and effort for hardware and software design depend heavily on the selected implementation method. You can carry out the development work fully in-house, or you work collaboratively with a development or technology partner. In-house development requires well-grounded PROFINET expertise and your own hardware and software development resources.

2.4.2 Competence Centers

PROFIBUS & PROFINET Competence Centers (PICC) are organizations with technical expertise that collaborate closely with the regional PI associations. Some technology partners are also a PICC. The PICCs provide technical support to device and system developers and conduct technical seminars and workshops. In particular, companies that want to develop their own devices with a PROFINET interface should attend a technology seminar by one of the PROFIBUS & PROFINET Competence Centers.

There are currently more than 50 PICCs in over 25 countries around the world. A list of these can be found at: www.profibus.com/PICC.

2.4.3 Test Labs

PI Test Labs (PITLs) are test labs accredited by PI that perform certification tests for PROFINET devices. There are currently 10 labs distributed around the world. A list of these can be found at: www.profibus.com/test-labs.

2.5 Is device certification required?

Yes. The goal of open standardized communication systems is vendor-neutral interoperability of the connected devices. This can only be achieved if the communication interfaces are designed in conformance with the specification. This concerns the mechanical design of the plugs and sockets, the communication hardware and software, and the EMC, safety, and environmental requirements.

To ensure compliance with the PROFINET standard, all PROFINET field devices must pass a certification test. Devices are not permitted to be marketed without a certificate attesting a successful test. PI-accredited test labs located around the world are responsible for this test. Details on the procedure for obtaining a certificate are provided in *Section 9*.

3 Components of PROFINET field device development

3.1 Which topics must be considered?

Figure 1 shows all important topics related to field device development. This recommendation contains detailed descriptions of the individual blocks.

3.1.1 Customer requirements

The development process normally begins with the customer requirements for a PROFINET field device. These differ depending on the area of application and industry sector and must be clarified before development. Assistance is provided here by the PROFINET profiles, conformance classes, and application classes. See also *Sections 4, 6, and 7* of this document.

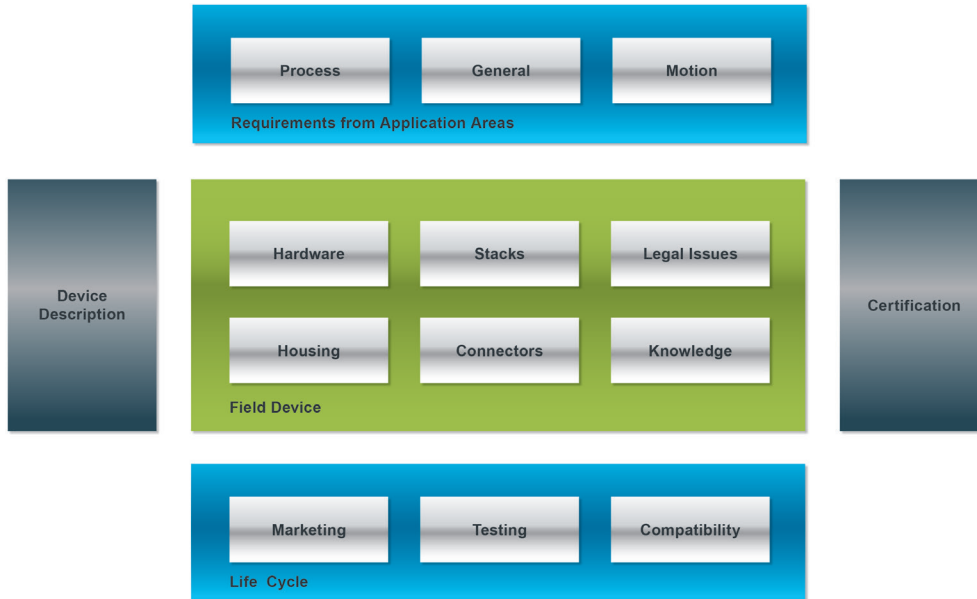

Fig. 1: Topics of PROFINET field device development

3.1.2 PROFINET field device

For actual development of a PROFINET field device, numerous hardware- and software-related topics must be considered. These are described in *Sections 4 to 8*. The brochure "PROFINET Technology - The Easy Way to PROFINET" provides a very helpful overview of available implementation options (www.profibus.com/pntb).

3.1.3 Device description file

The data-related description of PROFINET field devices is very important for their configuration and ease-of-use in engineering tools and is required for certification. *Section 6* deals exclusively with this topic.

3.1.4 Certification

Every PROFINET field device must be certified in order to prevent incompatibilities. *Section 9* provides detailed information about this.

3.1.5 Life cycle

PROFINET field devices undergo a life cycle that includes added functionality, hardware and software changes, compatibility, etc. *Sections 6 and 10* describe what needs to be considered.

3.2 Chronological sequence of field device development

Figure 2 illustrates the goal-oriented chronological sequence of PROFINET field device development. Comprehensive advice in the run-up to a development project is vital to enable optimal design of the development process. To assist with this, PI regularly conducts free one-day technology workshops (see address below for schedule) in Germany as well as in the USA. There you will receive an overview of implementation options, available technology, and technology providers (www.profibus.com/trainingevents/).

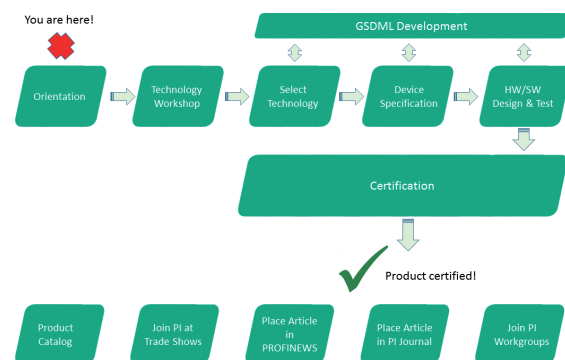

Fig. 2: Chronological sequence of PROFINET field device development

4 Start of development of a PROFINET field device

This section answers general, fundamental questions that arise according to experience at the start of a field device development project.

4.1 What device model does PROFINET use?

The device model describes all field devices in terms of their possible technical and functional features. It is oriented to a modular device.

The device model consists of slots, subslots, modules, submodules and channels, see Fig. 3. This also applies to compact devices. Their modules and submodules are virtual.

A field device has the following structure:

- A field device usually has two or more slots into which modules can be plugged.
- A module consists of one or more submodules. The slot and subslot numbers are used for addressing the I/O.

- The modules have no further tasks other than the structuring function. The actual inputs and outputs are implemented in the submodules. Acyclic services always address the submodules. Therefore, a module always contains at least one submodule.
- The structure with slots, subslots, modules and submodules may be understood as physical map of a modular remote I/O device. It may also be interpreted as software structure (as in object-oriented programming) with instances (slots, subslots) and classes (modules, submodules).
- A module may have a fixed number and structure of submodules or itself provide a number of free subslots that can be plugged in runtime.
- The data content of a submodule is always accompanied by status information, from which the validity of the data can be derived. Alternatively, the data of the channel can also be accompanied by status information.

Examples:

1. A modular device with physical plug-in modules into which the physical signal conditionings can be inserted. Modules with plug-in subslots intuitively map the hardware.

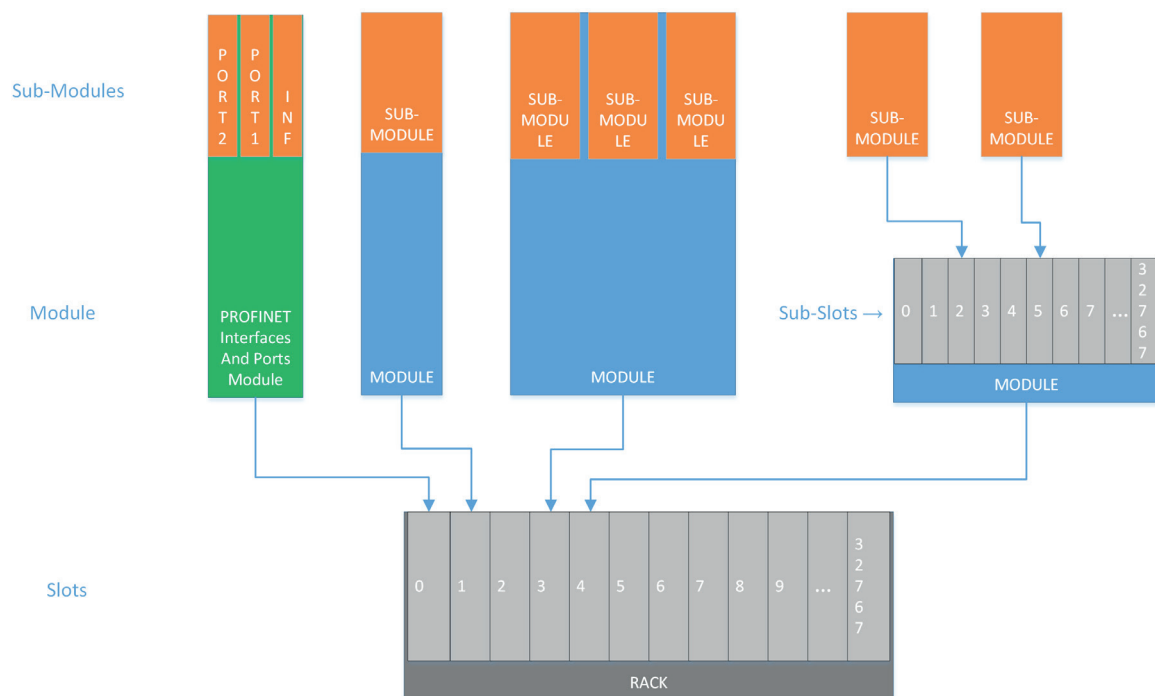

Note: Slots/Sub-Slots 0x8000-0xFFFF are reserved for PROFINET internal use

Fig. 3: Device model of a PROFINET field device

2. A device with fixed 8 analog inputs, 1 counter channel, 8 digital inputs and 4 digital outputs could, for example, be implemented as a device with one I/O module with, in turn, 4 submodules, one for each function. The structuring elements module, submodule and slot, subslot are only required here to address the various I/Os.
3. The module in slot 0 of Fig. 3 contains the submodules for the physical Ethernet ports and the PROFINET interface. It is the access point for communication. For redundant applications, two of these modules are required.

4.2 Modular or compact field device?

In its logical structure, a PROFINET field device is always modular in design. The modularity in the logical sense, however, does not require actual modularity in the electrical and mechanical design sense.

For example, a temperature sensor that supplies only a temperature measurement consists of one slot and one module. The combination of slot and module is fixed and cannot be changed. That is also the minimum configuration needed for a PROFINET field device.

If this temperature sensor now had to transmit two different temperature values (indoor and outdoor), the device might have two slots. The module with the indoor temperature would logically be inserted in the first slot and the module with the outdoor temperature in the second slot.

The device always starts with a configuration of slots/subslots with "inserted" modules. The general station description (GSD, see *Section 6*) specifies where the modules may be inserted.

Generally speaking, this process is comparable from the logical perspective to a PC in which various plug-in cards are inserted. Provided the requirements from slot and module fit (PCI-X x1... x16) and the firmware recognizes the changes, random rearrangement is essentially possible.

A general description of the device model can be found in the "PROFINET System Description", which is available for download free of charge (www.profibus.com/pnsd).

4.3 What is the diagnostics concept of PROFINET?

PROFINET provides neatly specified mechanisms for mapping diagnostics. If the mechanisms are correctly applied, the end user can easily recognize errors in a running system and react appropriately.

To ensure this, the method defined by PROFINET for transferring diagnostics must be used. A diagnosis must be entered in the "diagnostics database" of a device. If applicable, a diagnostic alarm is also sent to the IO controller. Use of a standardized method enables all available diagnostic messages from an IO device to be read out. Standard errors are described in the specification and require no texts in the GSD since they are stored by the controller manufacturer during engineering. As a result, the messages are the same for all device manufacturers.

For other errors, it is possible, with the aid of the GSD file, to output manufacturer-specific plain text diagnostic messages for. A multilingual GSD file even allows error texts to be displayed in the national language of the end user.

In addition to basic diagnostics that only indicate a cause, there are also extended diagnostics, in which it is possible to communicate a value in addition to the cause. With correct description in the GSD file, this additional value of the extended diagnostics can be displayed to the end user in plain text in a syntactically understandable context.

The PROFINET diagnostics concept should be used and not the same proprietary mechanisms using cyclic data.

4.4 I&M

4.4.1 What does I&M mean?

The acyclic data exchange "Read Record/Write Record" can be used to read out identification and maintenance information from IO devices. The I&M data (Identification & Maintenance) enable unique identification of devices and modules as well as their versions.

I&M functions are subdivided into 6 different blocks (IM0 ... IM5) and can be addressed separately using their index.

The IM0 function provides information about the hardware and firmware versions of the field device.

The I&M1-4 data contain system-dependent information, such as installation location and date, and are created during configuration and written to the device.

The I&M5 data provide information about the communication module of a field device, comparable to an electronic nameplate.

The I&M Guideline titled "Identification & Maintenance Functions" describes the concept in detail and is available as a free download to members (www.profibus.com/imf).

4.4.2 What does AMR mean?

Every internal component (firmware and/or hardware) of a device with PROFINET interface that can be replaced or updated for maintenance or repair purposes must be represented either using I&M data or an AM record.

By means of the asset management record (AMR), version information outside the PROFINET application space is provided, e.g. about hardware and firmware versions of locally connected devices or driver versions. The structure of the AMR is based on I&M0 but offers additional options for representing versions with a text string field. The figure 4 clarifies the roles of I&M and AMR.

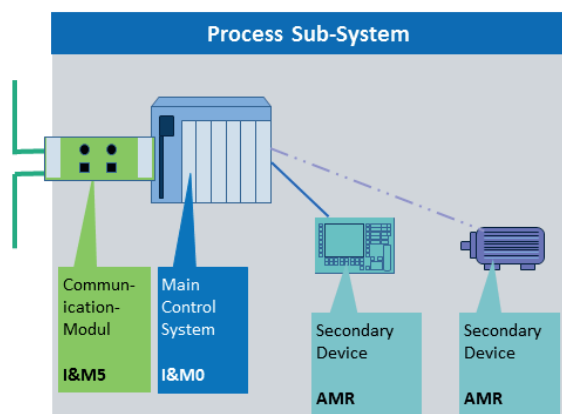

Fig. 4: Roles of the I&M and AMR data

4.4.3 What are the advantages of I&M and AMR?

Identification and maintenance functions are very important for complete detection of all components in an automation system. For example, the ability to read out identification information from a field device is very helpful for maintenance purposes. This allows inferences to be drawn regarding possible malfunctions or unsupported functionality in a field device.

I&M data have proven to be very useful in practice. Users place great value on the completeness of

these data records. Attention should be paid to ensuring correct I&M data from the outset when developing a new device.

4.5 When is IRT required?

4.5.1 IRT - Isochronous communication

Isochronism (from Greek iso = equal + chronos = time) is spoken of when an operation is repeated at exactly equal time intervals. Isochronism is produced in PROFINET through very exact synchronization (deviations of less than 1 μ s) of cycles in the devices. This enables input signals to be read in or output signals to be activated within a system at exactly the same time.

In connection with PROFINET, isochronism can be related to the communication itself as well as to the application. In this case, the communication can be isochronous without the application being isochronous, but not vice versa. Isochronous applications always require isochronous communication.

For isochronous communication, the bandwidth of the Ethernet communication is divided into two time slices (see figure 5): the so-called RED phase, in which only IRT data packets (PROFINET RTC3 frames) are allowed on the network, and the GREEN phase, in which normal Ethernet communication and normal non-isochronous PROFINET communication are allowed. Deterministic communication is achieved through the division of the bandwidth, i.e. the exact time at which IRT frames (RTC 3 data packets) will arrive is always predictable. This is the prerequisite for highly accurate clock-synchronized drive controls, such as are required for newspaper printing machines.

The isochronous cycle and the start of the RED phase are synchronized with high accuracy to significantly better than 1 microsecond. In addition, the individual packets are coordinated exactly with one another in the RED phase. As a result, very efficient communication is achieved. The start of the RED phase can also trigger local events (interrupts).

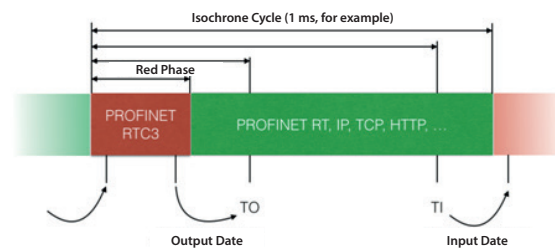

Fig. 5: Schematic representation of an isochronous cycle

4.5.2 Isochronous applications

In order to bring the concept of isochronous communication into a field device application, two signals are defined to provide RED phase timing:

- TI: At this time all participants in the isochronous operation must save their inputs.
- TO: At this time all participants in the isochronous operation must write their outputs.

Because all timing is defined based on the communication timing, all participants can capture and write out their IO synchronously across the IRT segment. This way, a highly precise, low jitter data exchange between a central controller (PLC, PAC, PC, etc.) and a field device is possible. The internal control loop timing of the controller is synchronized with all devices in the segment that way.

As a result, a closed control loop can be set up in a single cycle (e.g., 250 µs).

4.5.3 When should a field device support IRT?

When the field device (e.g. rotary encoder) will be used with high-performance drive solutions ("servo drive", "path control"), isochronous communication and isochronous application must be supported.

If a field device does not require isochronous application, it is still worth checking if the device would be beneficial to IRT users. In this case it makes sense to support IRT so that the device can be used within a IRT segment seamlessly.

In some industry sectors, such as the process industry, the use of IRT can be practically ruled out.

So does the new field device need IRT support?

Ultimately, the question of whether your field device must support IRT comes down to your customers and their requirements, or the industry sector in which the field device will be used.

4.6 Where is time-of-day synchronization required?

4.6.1 Time-of-day synchronization and Sequence of Events (SoE)

Time-of-day synchronization means that all local clocks of a system are synchronized from a time-of-day master, so that the same time-of-day is used everywhere. A drift correction of the local clocks is constantly made.

Systems that measure values or record events that are related to one another require time information so the values and events can be correlated in time. This applies, for example, to large process industry facilities of the chemical and pharmaceutical industry and the energy production sector.

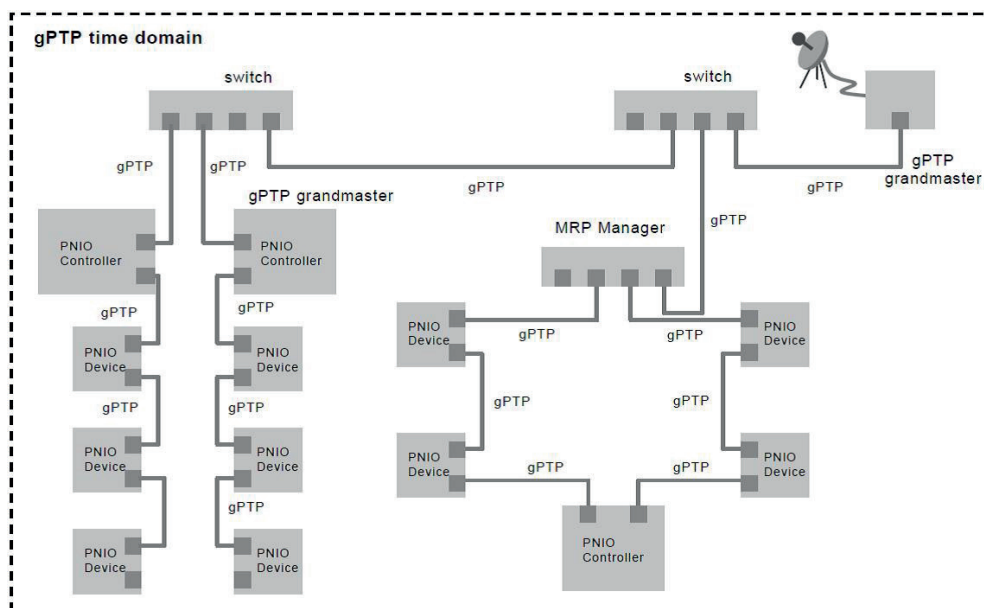

Fig. 6: Time-of-day segment synchronized via gPTP

In large distributed plants, a problem may trigger a series of subsequent events that are signaled to the control system via a multitude of error messages. The chronological sequence of the events is very important for analyzing problems. This is possible when every error message has an accurate time stamp.

The PROFINET solution for these use cases is described in the PROFINET Specification V2.3 Ed2MU3. Search terms are "Reporting System" and "SoE".

4.6.2 What time-of-day synchronization does PROFINET use?

For time-of-day synchronization, PROFINET uses the generalized Precision Time Protocol (gPTP), which is specified in IEEE 802.1 AS. This method is limited to networks based on IEEE 802 technologies such as IEEE 802.3 and IEEE 802.11 or Ethernet and WLAN. gPTP uses International Atomic Time (TAI, standing for French Temps Atomique International).

Figure 6 shows an example of a PROFINET (gPTP) time domain.

Selection of the time-of-day master

The best master clock is determined from among the available master clocks according to a procedure specified in 802.1 AS (in the figure, time-of-day via satellite). If this master clock fails, a redundant master clock can assume this role according to the same procedure (in the figure, time-of-day master of the PNIO controller).

Distribution of the time-of-day information

The time-of-day master sends synchronization frames to the time-of-day slaves at certain time intervals. The cable delay times and residence times in the network components are taken into account in the path of the synchronization frames through the network. As a result, the time-of-day slaves know, how long the synchronization message took to go from the master clock to the slave; they can take this into account in the time-of-day setting.

4.6.3 What is the difference between cycle synchronization and time-of-day synchronization?

Cycle synchronization

Cycle synchronization is needed for IRT and drive control. In principle, cycle synchronization is carried out using the same procedure as for time-of-day synchronization. Of importance here, however, is

the synchronous data exchange between the nodes of an IRT domain. For this reason, a network-wide cycle is generated for this use case. The relative times related to the cycle are of interest. An absolute time-of-day is not needed. An accuracy of +/- 1 μ s is achieved (network + application).

Time of day synchronization

Time of day synchronization is needed for time stamping measured values and local events, so that chronological analysis is possible. By means of periodic synchronization frames, the local clocks of the nodes are adjusted for this purpose. An accuracy of +/- 1 ms is achieved (network + application).

Note: Because gPTP uses the TAI format, a conversion to hours/days/date must occur in the visualization. This requires calendar knowledge.

4.6.4 What must be considered for implementation?

Precise time-of-day synchronization requires recording of send and receive times. These times must be recorded with maximum possible accuracy directly on the medium with hardware support. Communication modules with an integrated hardware-supported time stamping unit are therefore advantageous.

The specification of PROFINET time-of-day synchronization according to 802.1 AS is complete. Dissemination of the technology is the next step. Contact the technology partners for implementation support. You can find some addresses in the brochure "PROFINET Technology - The Easy Way to PROFINET" (www.profibus.com/pntb).

4.7 When are gateways appropriate?

Linking devices

PROFINET enables integration of other communication systems. Integration of open fieldbus systems or proprietary communication systems can be necessary or useful for a variety of reasons.

- Investment protection through reuse of existing installations or devices
- Special requirements that are not compatible with the Ethernet technology on which PROFINET is based
- ...

Integration is carried out by means of linking devices. On the one hand, these act as a PROFINET device. On the other hand, they communicate with the fieldbus system and map the fieldbus system

onto PROFINET. The guideline "Fieldbus integration in PROFINET IO" provides a general discussion of the integration of fieldbus systems. Fieldbus-specific documents (PROFIBUS, INTERBUS, AS-Interface, and others) are also available.

For member companies, these documents can be downloaded free of charge (www.profibus.com/spst).

4.8 Requirements for specific industry sectors (automobile manufacturers, process industry, etc.)

Some industry sectors define a required scope of functions for their applications, for example, **AIDA** ("Automation Initiative of German Automobile Manufacturers") for German automotive industry and **NAMUR** ("User Association of Automation Technology in Process Industries") for the process industry. The conformance classes conform to these requirements and describe an outline of various minimum properties. A detailed description of the conformance classes can be downloaded from the PI home page free of charge (www.profibus.com/pncc).

The exact requirements for the field devices must be agreed directly with the user. A general paper from PI concerning these industry sectors cannot be provided due to possible differences in detailed requirements.

4.9 From PROFIBUS to PROFINET

What is kept and what has changed?

Users with PROFIBUS know-how will discover similar concepts but also completely new processes in PROFINET. The reason for this lies in the new possibilities opened up by the use of Ethernet compared to RS 485 technology. Due to the high bandwidth and large node count, the limitations of the RS 485 technology no longer exist, and new fields in terms of performance and IT integration open up. A brief description of the basic PROFINET properties in comparison with PROFIBUS is provided below to make it easier for PROFIBUS users to classify them. The annotations (**keep**) and (**change**) are provided in the heading to indicate whether the PROFIBUS process has been kept or changed.

4.9.1 Modularity

Insertion/removal of modules (keep + change)

PROFINET has an expanded module concept compared with PROFIBUS. In addition to the modules that are inserted in slots in PROFIBUS, there are now submodules that are inserted in subslots of a module. When changing from PROFIBUS to PROFINET, it is generally advisable to make a PROFINET module from a PROFIBUS module. In doing so, a fixed submodule is then defined in the GSD file.

PROFINET has a neatly defined behavior of how the module configuration is changed at runtime. The processes for removal and insertion of modules are standardized and this mechanism works across vendors.

4.9.2 Provider / consumer principle

Difference compared to master / slave (keep + change)

In contrast to PROFIBUS, in which the master cyclically "fetches" the cyclic data from the slave, PROFINET uses the provider/consumer principle. This means that both the IO controller and IO device spontaneously send cyclic data independently.

4.9.3 IO data

IOPS now mandatory (change)

PROFINET uses the IOPS (IO Provider Status) within the cyclic data to display the validity of the IO data. This status has to be procured by the provider of the data. The input data must be labeled with the IOPS by the IO device application. Together with the output data, the IO controller supplies the IOPS, which must be evaluated by the IO device application. A scenario in which cyclic communication exists but the IO controller sends no valid IO data would be "STOP" mode.

4.9.4 Startup following a configuration difference

Startup occurs in spite of configuration difference (change)

In the event of a configuration difference between the preset and actual module configurations, communication is generally established in PROFINET. All correct submodules enter into cyclic data exchange. This differs from the standard system behavior of PROFIBUS. This behavior of PROFINET

allows a precise detection of the error, including exact information on the submodule differences between the preset and actual configurations.

4.9.5 Diagnostics

Diagnostics are mapped using diagnostic alarms, "incoming/outgoing" concept remains (keep)

In the case of diagnostics, such as overvoltage or wire break, PROFINET also knows "incoming" and "outgoing" events. These events are transmitted in the form of diagnostic alarms in PROFINET. A diagnosis is pending until it is deleted on the device.

4.9.6 I&M

I&M unchanged but now ALWAYS available in PROFINET and mandatory writable I&M1-3 (keep + change)

PROFINET relies on the proven handling of I&M data. In contrast to PROFIBUS, a PROFINET device must have a submodule whose I&M data records 1 to 3 are writable.

4.9.7 VendorID

VendorID once from PI, DeviceID becomes self-administered (not assigned by PI), must be used with I&M0 (same VendorID from PROFIBUS can continue to be used for PROFINET) (keep)

The "VendorID" from PI used for PROFIBUS field devices can also be used unchanged for PROFINET field devices. In contrast to PROFIBUS, however, in PROFINET the "DeviceID" will be administered by the device manufacturers themselves. It will be up to the device manufacturer to ensure that each DeviceID is used only once under its VendorID assigned by PI.

4.9.8 More than 240 bytes of acyclic data

More than 240 bytes of acyclic data possible, there will no longer be parameter data in the PROFIBUS sense, everything is transmitted via the normal acyclic channel (change)

In PROFINET, parameter data that come from the GSD are transmitted over the same transmission path "acyclic services" that acyclic accesses use during runtime of the system. There is no separate service for parameter data in PROFINET. PROFINET also allows larger acyclic data records with more than 240 bytes.

4.9.9 Transfer of configuration

The configuration is transferred and confirmed first, subsequently the parameters (change)

When the connection is established, only the submodule configuration is transferred and compared. The parameters are transferred to the submodules afterwards. This differs from the typical PROFIBUS process in which parameters are assigned first followed by configuring. In PROFINET, there is no parameter assignment of faulty modules.

4.9.10 The head station

The head station is modeled, configured, and parameterized in PROFINET (change)

In PROFINET, the head station of a module must be modeled and mapped onto PROFINET. This is carried out using the so-called DeviceAccessPoint and PDEV submodules (**Physical Device**). They must also be described in the GSD.

5 Mechanics

5.1 Are there special requirements for housings and connectors?

Some PROFINET field devices must meet requirements for higher protection classes that provide protection from touch, and ingress of water and dirt. A frequently used degree of protection for this is IP65. IP stands for International Protection and the number 65 means protection from dust and water jets. Additional protection classes are specified in ISO 20653. When such requirements exist for a PROFINET field device, the housing, connectors, and sockets must be designed according to the respective IP protection class.

5.2 Which cables does PROFINET use?

5.2.1 PROFINET copper cabling

A PROFINET copper cable is typically a 4-wire shielded copper cable (star-quad). For high transmission rates (1000 Mbps), 8-wire cables are specified.

Fiber type	Core diameter	Sheath diameter	Transmission distance (typical values)
POF	980 μm	1 000 μm	Up to 50 m
PCF	200 μm	230 μm	Up to 100 m
Multimode	50 or 62.5 μm	125 μm	Up to 2 000 m
Single mode	9 to 10 μm	125 μm	Up to 14 000 m

Tab. 1: Achievable transmission distance of FOC fiber types

The various cable types differ:

- in the wire design (solid/flexible)
- and/or the sheathing.

The wires are color-labeled.

In 4-wire cables, the wires of pair 1 have a yellow and an orange insulation, while the wires of pair 2 have a blue and a white insulation. The wires of the pairs are arranged in a crossed manner opposite one another.

8-wire PROFINET copper cables consist of 4 cable pairs with the colors green, blue, orange, and brown and the associated white wires. As in standard Ethernet applications, the maximum distance between communication endpoints for copper cables is limited to 100 m. This transmission distance is defined as PROFINET-end-to-end-link.

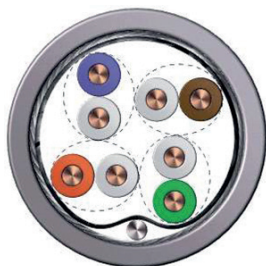

Fig. 7: Cross-section through an 8-wire PROFINET cable

5.2.2 PROFINET fiber-optic cabling

In areas where electromagnetic interference fields or high potential differences can be anticipated, you should use fiber-optic cables (FOC) for connection of automation islands and systems. The use of fiber-optic cables eliminates electromagnetic influences and/or grounding-related equalizing currents through the shields of PROFINET copper cables.

The advantages of FOC transmission technology compared to copper cable are:

- FOCs generally span larger distances than copper cables
- FOCs enable electrical separation between the connected plant sections
- FOCs are immune to electromagnetic interference (EMI)

When fiber-optic cables are used for PROFINET, four different fiber types are possible. The selection of a fiber type must take into consideration the requirements of the automation project.

The following fiber types are available for selection:

- Plastic fibers plastic optical fiber (POF)
- Glass fiber polymer clad fiber (PCF)
- Glass fiber (multimode, single mode)

With each fiber type, only a limited transmission distance can be achieved due to the respective damping and utilized wave length of the optical signal.

5.3 Which plug connectors are available for PROFINET?

PROFINET cables are provided with plug connectors at both ends. The combination of the plug connector on the cable and the socket is viewed as a pair.

5.3.1 RJ45 plug connector for copper cable

The RJ45 plug connector is suitable for connection to terminals and network components. An essential criterion for usability of plug connectors is their manageability on site. The RJ45 plug connector in IP20 version is used in the control cabinet. Outside the control cabinet, the harsh environment must be allowed for. Here, the RJ45 Push-Pull plug connector in IP65 or IP67 is used. The RJ45 standard also has the advantage that it can be used for fast, straightforward connection of notebooks or engineering tools

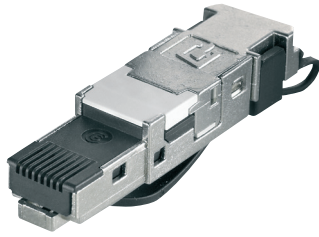

RJ45 plug connector in IP20

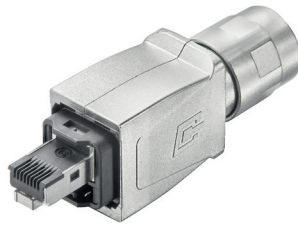

RJ45 Push-Pull plug connector in IP67

Fig. 8: RJ45 plug connector for copper cable



Connector
M12-D coded plug connector in IP67



Socket
M12-X coded plug connector in IP67

Coding of the connector face



Fig. 9: M12 plug connector for copper cable



SCRJ plug connector in IP20

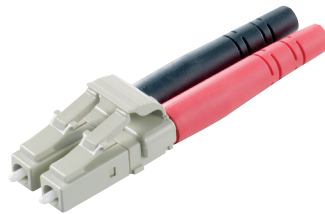

LC Duplex plug connector in IP 20



SCRJ Push-Pull plug connector in IP67

Fig. 10: Plug connectors for fiber-optic cable

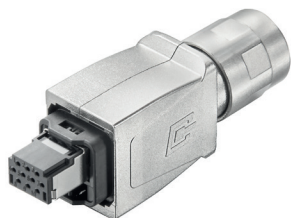

Signal plug connector - Push-Pull plug connector in IP65

Fig. 11: Signal plug connector

in service situations. The RJ45 plug connector in IP20 is standardized in IEC 60603-7. The RJ45 Push-Pull plug connector in IP65 is standardized in IEC 61076-3-117 and is used in the German automotive industry as the primary standard plug connector for PROFINET (see figure 8).

5.3.2 M12 plug connector for copper cable

For use in harsh industrial environments with degree of protection IP67, PI has specified the M12 plug connector, which offers a safe connection for sensors/actuators. The M12 is standardized in IEC 61076-2-101. For higher transmission rates in harsh industrial environments, the M12 Type X plug connector is suitable (see figure 9).

5.3.3 Plug connectors for fiber-optic cable

The SCRJ (POF/PCF) and the LC-Duplex (glass MM/SM) plug connectors are designed for PROFINET data transfer via fiber-optic cable (see figure 10). The basic versions of these connectors are appropriate for use in control cabinets (IP20 degree of protection). SCRJ- or LC-Duplex push-pull plug connectors are available for harsh environments (IP65 / IP67 requirements).

5.3.4 Plug connectors of type BFOC and SC for FOC

The use of plug connectors of type BFOC / 2.5 (IEC 60874-10) and the SC connector system (IEC 60874-14) is not recommended for new automation systems.

5.3.5 Signal plug connector

For PROFINET signal applications, the standardized 10-pole Push-Pull plug connectors of variant 14 are used. These are characterized by the fact that up to 10 signal inputs can be inserted with one Push-Pull plug connector. The plug connector is standardized in IEC/PAS 61076-3-119 (see figure 11).

5.4 What need to be considered for device integration of connectors and sockets?

The integration of copper interfaces or even fiber-optic cable interfaces follows the tolerance situation of the printed-circuit board and the wall thicknesses in the device as well as the tolerances of the utilized interface. The device manufacturer must optimally design the position of the interface to guarantee a reliable connection of the device to the interface. Drawings are available in the guideline "Cabling and Interconnection Technology" for PROFINET copper and fiber-optic cable, which enable easy integration of the interface (see figure 12 and 13).

This guideline is available for free download via the PI website (www.profibus.com/pncit).

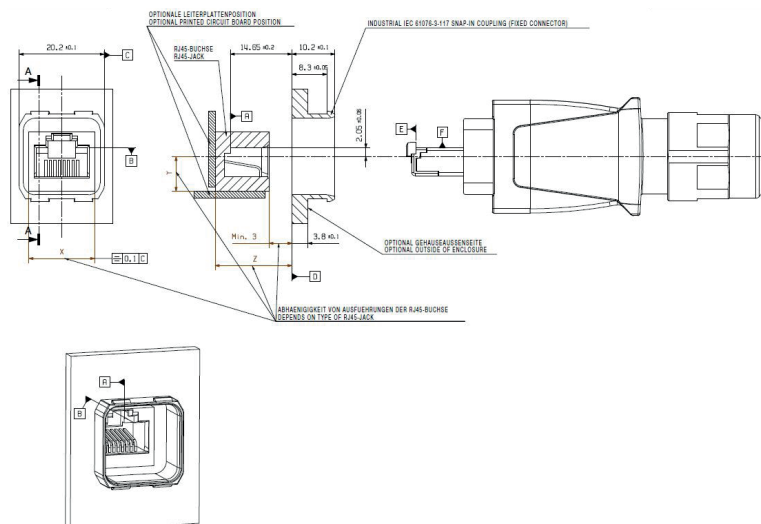

Fig. 12: Design rules for RJ45 Push-Pull connector type

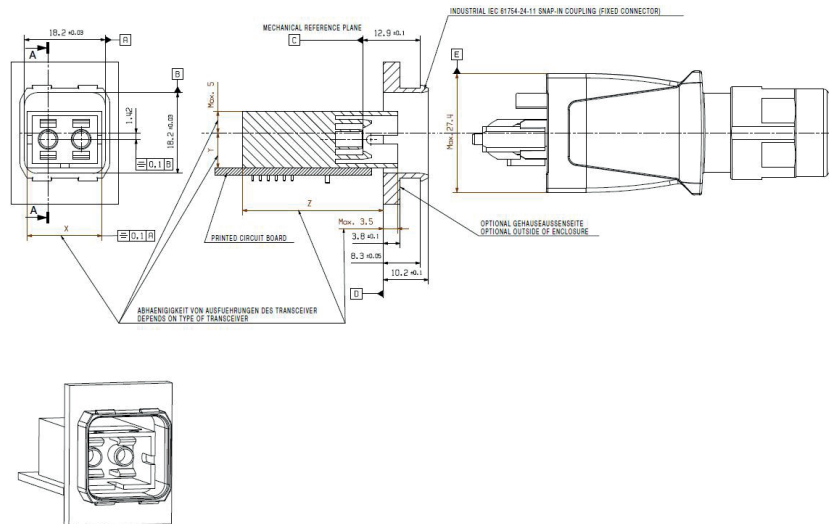
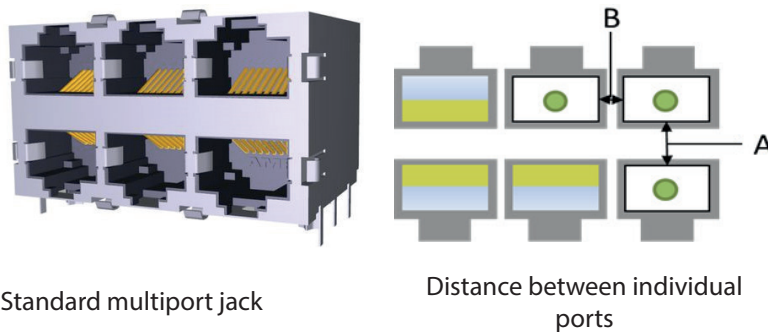

Fig. 13: Design rules for SCRJ Push-Pull connector type



Standard multiport jack

Distance between individual ports

Fig. 14: Multiport device

Multiport plug connector

When RJ45 multiport jacks are used, compatibility with industry-standard IP20 RJ45 must be ensured. Due to the industry-compatible design, field-assembled plug connectors are somewhat larger than patch cords from the office environment. For this reason, incompatibilities with industry-standard RJ45 can arise when using very compact multiport jacks.

Due to the non-standardized distance between ports in the case of multiport RJ45 jacks, attention must be paid to distance A and B when selecting the multiport. The dimensions of the multiport must be such that commonly used industry-standard RJ45 plug connectors can be used.

Additional information on copper cabling and fiber-optic cabling can also be found in the "PROFINET Cabling and Interconnection Technology Guideline for PROFINET".

Additional information on routing and grounding copper cabling can be found in the "PROFINET Installation Guideline".

It can be downloaded free of charge : www.profinet.com/pnig.

5.5 What needs to be noted for electromagnetic compatibility (EMC)?

5.5.1 Grounding and shielding concept for PROFINET

To ensure the EMC of the PROFINET system, the entire communication route is shielded up to and into the device. Optical transmission media are the exception.

PROFINET operates with shielded copper cables whose shield is routed via the connector to the device. Metal connectors and device sockets are therefore used, see figure 8, 9 and 12-14.

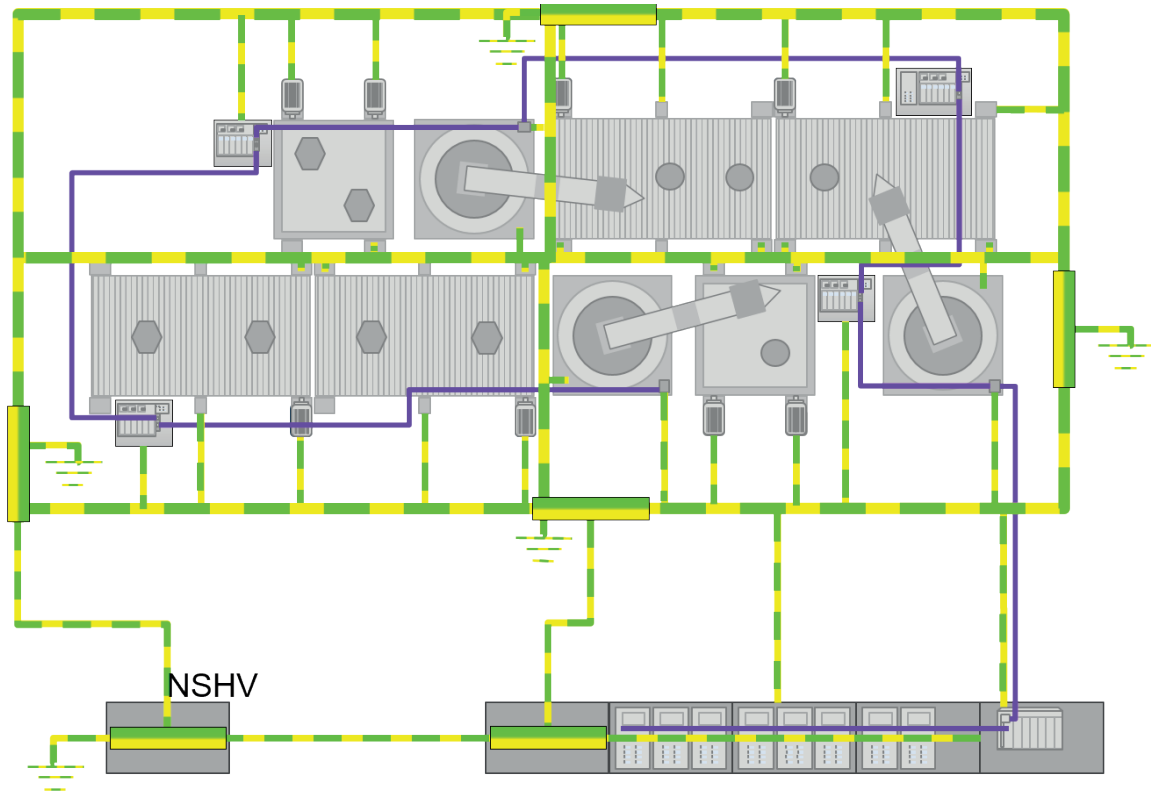

Fig. 15: Equipotential bonding and grounding

In the device, the shield is connected low-impedance to the enclosure (provided it is made of metal) or to the functional grounding.

If the contact of the cable shield to the functional earth screw or a contact on the DIN rail, is not directly established via the housing of the device, but instead via strip conductors on the printed circuit board, interferences can occur. These interferences may cause effects on other conductors on the printed circuit board. The EMC compatible routing and highest possible current carrying capacity of these conductors should be key considerations when designing the device.

Potential differences can occur in a system and lead to compensating currents. These compensating currents may also flow through the cable shield and interfere with the communication as the cable shields are connected at both ends with the equipotential bonding system.

To prevent this, the installation should be provided with a low-resistance equipotential bonding system and preferably with an equipotential bonding system that is meshed (MESH-BN). A so-called Common Bonding Network (CBN) is recommended here, which implements the protective grounding and the functional equipotential bonding using a

combined system. Figure 15 shows the principle of the equipotential bonding. For more information on this topic, please refer to the document: Functional Bonding and Shielding of PROFIBUS and PROFINET. Order No.: 8.101.

The cable shield is generally connected via the device enclosure to the Common Bonding Network (CBN). A low-impedance connection should be provided at the device for the connection to the CBN (e.g., for 2.5 ... 4 mm² Cu).

In a mesh-type equipotential bonding system the currents are distributed along many parallel branches. Only low currents are therefore expected on the cable shield. If currents on the cable shield cannot be eliminated, and if this leads to disturbances in communication, the use of optical fibers should be considered.

5.5.2 Connecting cable shields

The cable shield should be connected with low-impedance via the connector enclosure. This can, e.g., be accomplished using a conductive housing that is connected to CBN (such as standard mounting rail, mounting plate).

The connection of the cable shield with the CBN on both sides provides an effective shielding against magnetic fields. The magnetic interference fields induce a current in the cable shield which can act against these fields.

Fig. 16 shows an example of the shield structure of a 4-core PROFINET cable.

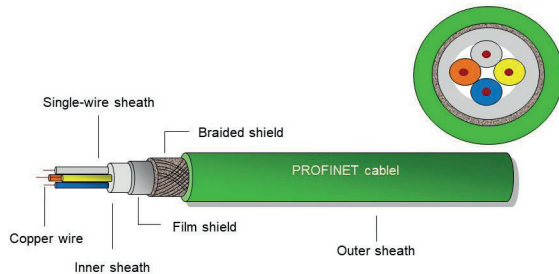

Fig. 16: 4-core PROFINET cable

5.5.3 Functional grounding

The connection of a device with the CBN is commonly described as functional grounding, provided the grounding features no protective function. The functional grounding of the PROFINET field device should preferably be implemented via one or more contacts with low impedance. A flat contact of the enclosure with the mounting plate or the standard mounting rail can be used, for example, for this purpose.

A functional grounding of the device with low-impedance enhances the interference immunity of the device and the grounding and, in turn, the effectiveness of the cable shields.

Note: The term "Functional grounding" suggests a 0V potential. But in reality, that's often not true. When large loads are installed in the proximity of the devices, they significantly increase the potential in the surrounding area by more volts.

A functional grounding via the power supply cable usually has a higher impedance than a functional grounding via the enclosure. Furthermore, the power supply protective conductors are often burdened by the currents induced in these conductors. When possible, therefore, this potential should not be used for the functional grounding of the device.

5.5.4 Functional grounding for devices with 24V supply

The following should be noted for devices that are supplied via an external 24 V supply:

1. The device should not have a low impedance connection between the minus pole of the 24 V supply and the functional grounding.
2. If a connection is present, it should be detachable and open in delivery state. The operating instructions should provide information on the effects, if the jumper is inserted between the minus pole of the 24 V supply and the functional grounding.
3. If a permanent connection between the Minus of the 24 V supply and the functional earth connection is present, this must be specified in the documentation.

A single connection between the minus pole of the 24 V supply and the functional grounding should be present in each 24 V supply system. In the event of multiple connections between minus pole of 24 V supply and functional grounding, operational currents can occur in the grounding system.

5.5.5 Protective grounding and functional grounding for devices with 230/400V supply

For devices with 230/400V supply:

There must be no connection between the neutral conductor and protective conductor in the device. The neutral conductor must be separated from the protective conductor in devices. See VDE 100, part 510, section 516.

A protective grounding of the device must be provided in every case for safety reasons. This is usually provided via the PE conductor in the connecting cable. In addition to the protective grounding, a functional grounding can also be provided via the device enclosure.

5.5.6 Functional grounding for M12 power supply connectors

The document "PROFINET Cabling and Interconnection Technology" (Version 4.00 - Date February 2017 Order No.: 2.252) defines in section 13.1 M12 power supply connectors with an L-coding. This plug connector is available in two versions. One version is a 4-pole version without a connection for functional grounding, the other is a version with a connection for functional grounding. Since it is assumed that this plug connector is used for "looping through" the power supply in a linear topology, the following recommendations should apply:

It is recommended to use the M12 power supply connector in the 4-pole version without contact

for the functional grounding. At the same time, it is recommended to install the functional grounding via the enclosure.

If the 5-pole plug connector version is installed, a functional grounding should be installed via the enclosure in addition to the functional grounding via cable.

The statements apply accordingly also for 7/8" plug connectors and push-pull plug connectors (version 14).

A functional grounding with low impedance is not ensured when the power supply is looped through multiple devices. In the event of a functional grounding via the connection cable in a linear topology, leakage currents are routed through multiple devices at the same time.

5.6 Should the MAC address be visible on the device?

In its as-delivered state, a PROFINET device has no set device name. Rather, it has only a MAC address for addressing. This is permanently stored in the device, is unique worldwide, and generally cannot be changed. The cyclic user data exchange takes place merely by addressing with the MAC address when the controller (IO controller) and IO device are in the same subnet. The MAC address is marked on the housing or the nameplate of many PROFINET field devices. This facilitates commissioning and subsequent searches for the MAC address on-site. For this reason, it is recommended that the MAC address be printed or lasered on the device and, namely, in such a way that it is legible when the device is installed.

5.7 Do LEDs have to be incorporated?

5.7.1 Status LEDs

Every PROFINET device must come with at least one (1) Status LED - the "DCP Signal" service is indicated by this LED. In principle, this service can also be indicated with other methods - e.g. with a display. If a display method other the Status LED is chosen, it is recommended that it be coordinated with the test lab designated for certification before developing or designing the device.

The PROFINET standard makes no other specifications. In practice, however, provision of the following LEDs has proven positive.

- "Link + Activity" LED per Ethernet port, see below
- DCP Services LED, see above
- (green) LED that indicates that the supply voltage is active and the module is ready for operation
- (red) LED that indicates whether a diagnosis exists (e.g., wire break, overvoltage, etc.)
- (red) LED that indicates whether an error exists (e.g., no cyclic communication, internal hardware problem, etc.)

A good approach has turned out to be the incorporation of two bi-color LEDs. Even if the LEDs are covered when the device is operating (e.g. IP67 device), it is much easier to analyze the device with the help of the LEDs during commissioning.

5.7.2 Link / Activity LEDs

Link/Activity LEDs indicate the status of the physical Ethernet connection and should be present for each port. They should be arranged in such a way that the relationship between port and LED is easy to recognize.

6 GSD (General Station Description)

6.1 What is a GSD?

The GSD is a data-related description of the PROFINET field device, which contains all information for data communication and engineering.

This includes:

- Communication parameters, communication capabilities
- Device structure (if relevant for communication: modules, submodules)
- Catalog information (device designation, etc.)
- Structure of the cyclic data and startup parameters
- Definition of the diagnostic information (alarms only)
- Engineering information (icons, images, texts, values)
- Order numbers (for selection and ordering)

The GSD does not describe:

- Complex user interface (graphics, charts, wizards)
- Dependencies (e.g., among variables)
- Complex slot rules
- Application diagnostics
- Device-specific business logic
- Mechanical data, connection diagrams

The GSD does not replace the device manual.

The GSD is essential for a PROFINET field device because engineering is impossible without it. Every manufacturer of a PROFINET field device must create an associated GSD file. It will be checked as part of the certification test.

The engineering tool obtains knowledge about the device only on the basis of the GSD data. The GSD file is read into the engineering tool (e.g., programming device) once for this purpose. Afterwards, the field device can be configured, for example, from the product catalog of the engineering tool.

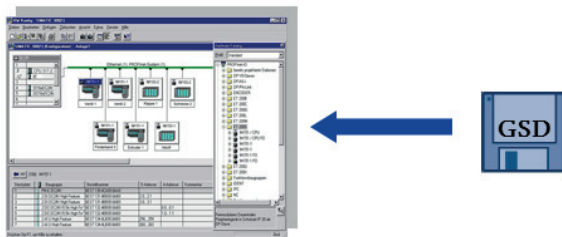

Fig. 17: GSD and engineering tool

During device development, the GSD and its properties must be taken into consideration early on so that the device functions can also be mapped by means of data. If this happens too late, unnecessary effort for making changes may result. Additional general information about the GSD can be found in Section 2 of "PROFINET Technology and Application - System Description", which is available as a free download at: (www.profibus.com/pnsd).

6.2 What is the GSDML (GSD Markup Language)?

The GSD file is an XML file that can be created and edited with commonly used tools (see *Section 6.7 Tools*). GSDML is the description language of the GSD file. It defines the device properties using multiple levels and is thus well-suited for hierarchical mapping of PROFINET field devices. Figure 18 shows, for example, the general part for identification of the field device of a simple GSD file.

6.3 What information does the GSD file contain?

The interaction between the GSD file and engineering is illustrated in figure 19. For example, it shows how a field device is classified in the product catalog during engineering based on information from the GSD file (see also XML representation in figure 18).

The basic structure of the GSD file is apparent from the block diagram in figure 19.

6.3.1 Profile Header

The Profile Header contains general profile information, such as the profile name, profile version, and profile publisher.

6.3.2 Profile Body

The Profile Body contains the actual data of the field device. It contains information for unique identification, indicates the product family the device belongs to, and describes all communication-related properties of the field device. This main section of the GSD file can be very extensive, depending on the scope of functions and the device structure, because the following information is needed:

- Communication capability
- Configuration
- Parameter assignment
- Representation
- Diagnostics
- References to graphics and texts

The respective items are described in detail in the GSDML Specification. It is available to member companies for free download (www.profibus.com/GSDML).

6.4 What needs to be considered for the VendorID and DeviceID for the GSD?

The PROFINET field device of the manufacturer must be uniquely identifiable in the engineering tool and later in the actual automation system. This is achieved by the combination of the VendorID and a specific DeviceID. See also *Section 2*.

The DeviceID, which must be unique within the manufacturing company, is specified by the manufacturer themselves. To prevent duplicate assignments, it is recommended that the assignment be coordinated with the marketing or product management department within the company. A

```

<?xml version="1.0" encoding="ISO-8859-1"?>
<!-- ***** Simple example GSD V2.31 File Set xsi:
- <ISO15745Profile xsi:schemaLocation="http://www.profinet.com/GSDML/2003/11/DeviceProfile ..\xsd\GSDML-DeviceProfile-V2.31.xsd"
xmins:xsi="http://www.w3.org/2001/XMLSchema-instance" xmlns="http://www.profinet.com/GSDML/2003/11/DeviceProfile">
  <!-- ProfileHeader Definition as defined in ISO15745-1. Please do not change the content. -->
  - <ProfileHeader>
    <ProfileIdentification>PROFINET Device Profile</ProfileIdentification>
    <ProfileRevision>1.00</ProfileRevision>
    <ProfileName>Device Profile for PROFINET Devices</ProfileName>
    <ProfileSource>PROFIBUS Nutzerorganisation e. V. (PNO)</ProfileSource>
    <ProfileClassID>Device</ProfileClassID>
    - <ISO15745Reference>
      <ISO15745Part>4</ISO15745Part>
      <ISO15745Edition>1</ISO15745Edition>
      <ProfileTechnology>GSDML</ProfileTechnology>
    </ISO15745Reference>
  </ProfileHeader>
  - <ProfileBody>
    - <DeviceIdentity DeviceID="0x0008" VendorID="0x002A">
      <InfoText TextID="TOK_DevIdent_InfoText"/>
      <VendorName Value="SIEMENS"/>
    </DeviceIdentity>
    - <DeviceFunction>
      <Family ProductFamily="DEVKIT" MainFamily="I/O"/>
    </DeviceFunction>
    - <ApplicationProcess>
      - <DeviceAccessPointList>

```

Fig. 18: General part of a GSD in XML representation

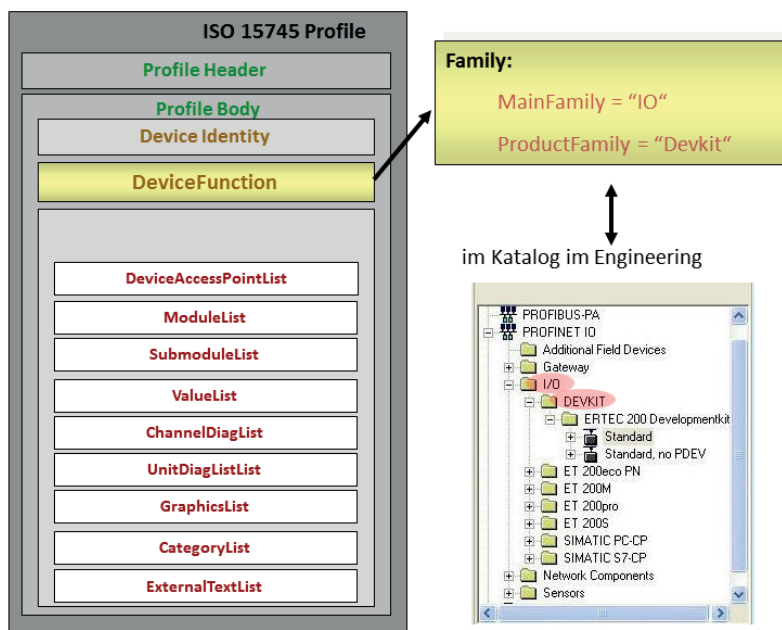

Fig. 19: Interaction between GSD and engineering

pragmatic approach has proven to be a blockwise assignment of DeviceIDs to departments or the management of DeviceIDs in a central list.

Besides the method using VendorID and DeviceID, which is essential for engineering and for productive data communication, the option to identify a field device during engineering using its order number also exists. This is a convenience option for simplifying the ordering process.

A detailed description of the device identification and its handling in the engineering tool and during productive operation can be found in the GSDML Specification (www.profinet.com/GSDML).

Note: In practice, it has happened that device manufacturers implementing their PROFINET connection with a communication module leave the VendorID of the communication module or its manufacturer unchanged in the GSD. This results in false interpretations in subsequent system diagnostics because the device manufacturer is not displayed but rather the module supplier. It must therefore be ensured that the VendorID of the device manufacturer is used.

6.5 What effects does the application have on the GSD?

The requirements of the application call for certain device functions that are in turn mirrored in the GSD. The philosophy of the GSD is that every technical feature is described by a separate element or attribute. If there are technical dependencies on other features, this is described in the GSDML Specification and is also checked by the GSD checker (see *Section Tools, chapter 6.7*).

In addition, there are marketing rules that are not technical in nature. Thus, if feature x and y are supported, then z must also be supported. This serves to reduce the number of variants. "Conformance Classes" and "Application Classes", in particular, play a role here.

6.5.1 Conformance Classes (CC)

The conformance classes provide a practical summary of the various minimum properties. The certification of a device according to a CC is done to ensure that selected field devices have clearly defined minimum properties with respect to functionality and interoperability. The CCs conform to the requirements of certain industry sectors, such as factory automation or motion control. A description of the CCs is available as a free download (www.profibus.com/pncc).

6.5.2 Application Classes (optional)

Application classes define device properties so that the application function can be provided and is interoperable with the system properties. An application class describes the minimum scope for the corresponding use case in an automation system.

The following application classes are defined:

- Isochronous Application
- Process Automation
- High Performance
- Controller to Controller
- Functional Safety

If the manufacturer specifies an application class in the GSD file, the corresponding minimum scope will also be tested during the certification test.

6.6 What should be considered for "Life Cycle Management" of the GSD?

The life cycle management of the GSD can be influenced by newer versions of the GSDML or a newer version of the PROFINET field device. See also *Section 10*.

6.6.1 What are the effects of changes to the GSDML?

Further developments of the PROFINET technology can affect the GSDML. In the further development of the GSDML, it must be ensured that existing GSD files are always compatible with a newer GSDML version. That is, an engineering tool with new GSDML version also understands GSDs based on older GSDML versions (upwards compatibility).

There is also a remedy for the other direction. If a GSD based on a new GSDML version encounters an engineering tool that supports only an older GSDML version, the GSD objects that can be skipped by the (older) tool when reading the GSD can be specified without this triggering incorrect behavior. The attribute "RequiredSchemaVersion" (minimum version or newer) was introduced for this for the DAP, module, and submodule objects.

6.6.2 Do further developments of the field device influence the GSD file?

If the PROFINET field device is further developed and functions are added, for the same PROFINET level or equal GSDML version, only a new version of the GSD file containing the new functions is required.

If modules are added to a modular field device, these may be integrated without recertification but the GSD file must be expanded. Recertification is required only when new modules also introduce new functions that were not able to be tested previously. Example: If a device did not support PROFIsafe previously and a PROFIsafe module is now added, the PROFIsafe part must be recertified. This pertains to the DAP as well as to the actual PROFIsafe module.

If features are added which are available starting from a newer PROFINET version, and which can be described only with a newer GSDML version, the entire GSD must be brought up to the newer GSDML version. The UpgradeGSDML tool is available here: (www.profibus.com/pngsdml).

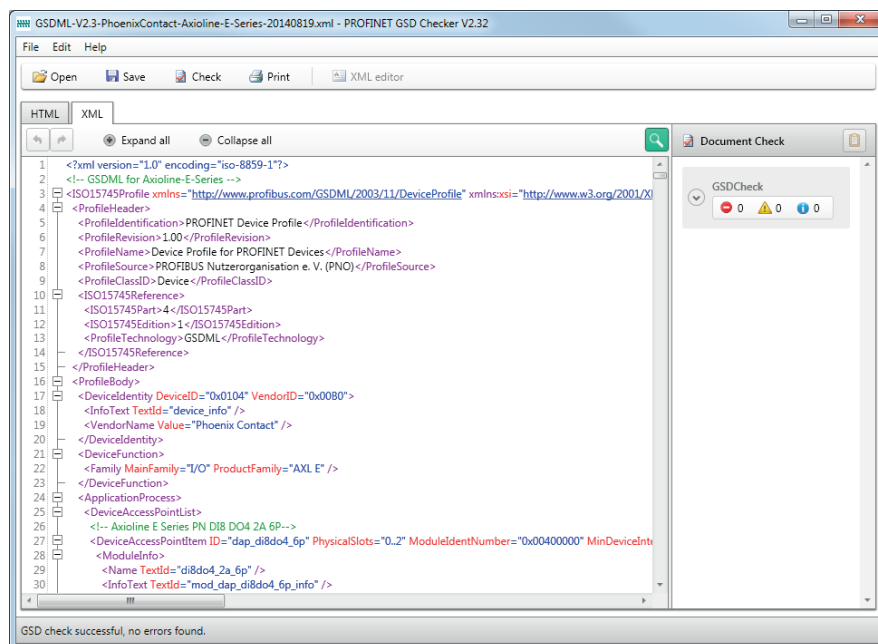

Fig. 20: XML representation in the GSD Checker

6.6.3 How do I make the GSD available to my customers?

The GSD file must be available in order for the PROFINET field device to be used. Therefore, the GSD file is customarily supplied with the field device. Many manufacturers also offer the GSD file as a download on the internet as part of the device presentation. This allows the manufacturer to make the current version available at all times. Examples of this can be found in the Internet product catalogs of the field device providers. Here is one example: www.siemens.com/profinet-gsd.

6.7 Tools

6.7.1 What tool can I use to check a GSD?

The PROFINET GSD Checker software can be used to check the GSD file. This tool is made available to members free of charge on the PI website (www.profibus.com/pngsdc). It offers two basic functions:

- Display of the content of a GSD in clear HTML representation
- Validation of a GSD against the schema files and checking of the rules that go beyond the schema and are documented in the GSDML specification.

In addition, the checker provides the schema documentation (human-readable form of the schema) for the GSD. The PROFINET GSD Checker comes with a simple XML editor. But, the GSD Checker allows any other XML editors to be integrated.

6.7.2 Which tools are used to create a GSD?

The GSD can be created or edited with an XML editor. A more convenient option is to use an XML editor that is "schema-aware". That is, an XML editor that reads in the GSDML schema and then, based on this knowledge, automatically adds all mandatory elements/attributes and has IntelliSense (thus auto-completion as soon as the previously entered characters are unique). These functions are offered by editors such as Altova XMLSpy or oXygen (liable for costs).

Editors for XML:

- Altova XMLSpy (www.altova.com)
- <oXygen/> xml editor 11.2 (www.oxygenxml.com)
- Microsoft XML Notepad 2007 2.5 (www.microsoft.com/en-us/download/details.aspx?id=7973)

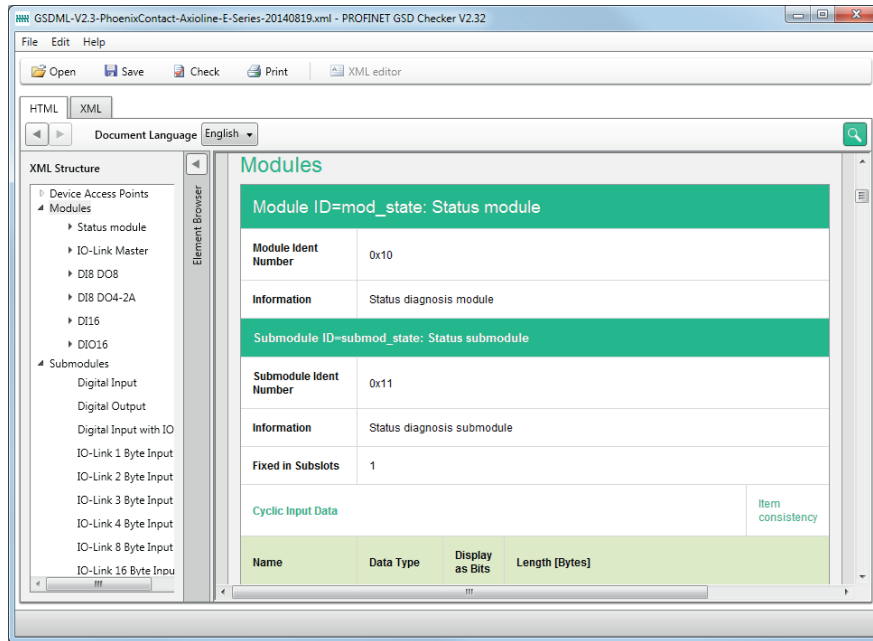

Fig. 21: HTML representation in the GSD Checker

6.8 Good practice

6.8.1 Creating the GSD

A pragmatic way to create the GSD is to use the XML checker and the supplied examples. The correct structure is easy to recognize from the examples, and these can serve as a basis for the new product.

Another easy option is to use communication modules or development packages. Module suppliers also provide an example GSD for the module. Here, however, it must be ensured that this GSD is adapted to the field device and the device manufacturer.

If the PROFINET connection is realized with a development package, creation of the GSD also requires little expertise and is most quickly accomplished with support of the technology suppliers. When customers rely on the technology components (e.g. ASIC, Development Kit), they receive executable device software with example application and example GSD files. Here too, it must be ensured that the example GSD is adapted to the field device.

6.8.2 Checking the GSD

The structure of an XML document can be checked using a schema file. This is referred to as validation of a document. This operation includes checking whether the element structure and the attributes used in the XML document match the schema definition. For example, the schema file contains

information on whether an attribute must be present and which values are allowed for the attribute.

When the GSD Checker is used, expertise in the function and use of schema files is not needed, because these are automatically installed by the PROFINET GSD Checker and used for the validation.

Also very helpful are one or two commonly used engineering tools for ensuring that the GSD works as desired, the graphic is displayed appropriately, and the result then meets expectations.

7 Profiles

7.1 What are profiles?

Application profiles specify the form, i.e., syntax and meaning, in which process data and selected device parameters and device functions are to be exchanged between the nodes via the communication system. Application profiles describe the set of properties for all devices of a class that must be implemented ("mandatory") by manufacturers when developing "profile-compliant" devices of this class, together with other properties that can be implemented ("optional").

Profile specifications contain, in particular:

- Uniform definitions of terms
- The functional device structures or architectures (device models)

- Data structures for the process inputs and outputs (switching states, measured values or manipulated variable values, product information, etc.)
- Structure and function of the field device parameters to be communicated (e.g. configurations, setpoints and actual values, units, limit values, measuring ranges) using attributes such as name, data type, value range, access rights, etc.
- Profile-specific identification and maintenance information
- Diagnostic methods, messages, and codings

7.1.1 What are the benefits of profiles?

Through the specification of device-specific data above the actual communication level, devices of a certain class can be addressed from the IO controller in the same way irrespective of the device vendor. As a result, only a host driver is needed and the user program is simplified.

7.1.2 What profiles are available?

The available PROFINET profiles are listed in the download area of the PI web page and are available for members free of charge: (www.profibus.com/download/profiles).

You can find explanatory videos at: www.profibus.com/psyt.

Four of these profiles - PROFIsafe, PROFIdrive, ENCODER profile, and PROFInergy - are briefly explained below.

7.2 PROFIsafe

Functional safety is a serious issue in automation. For this reason, implementation and use of PROFIsafe technology must be approached carefully. All companies and institutions involved are obligated to commit themselves to the so-called "PROFIsafe Policy" (www.profibus.com/psp).

A comprehensive overview of the mode of functioning and safety-relevant topics is provided in the PROFIsafe System Description, which is available as a free download (www.profibus.com/pssd).

In the following description, some terms are preceded by "F-", which stands for "fail-safe". Fail-safe is the ability to reliably protect a system from hazards, or to reduce the risk to an acceptable level with corresponding technical and organizational measures.

7.2.1 Where is PROFIsafe required?

Every industrial process always carries risk to a greater or lesser extent of

- human injury/death
- environmental harm
- property damage

For most processes, it is relatively easy to prevent risks without placing excessively high requirements on the automation systems. However, there are also typical applications with high risks. These include presses, machine tools, robots, conveyor and packaging systems, high pressure processes, offshore technology, fire and smoke alarms, burners, cableways, etc. These types of processes require special care and technologies.

7.2.2 What principle do PROFIsafe field devices use?

For PROFIsafe, the transmission channels are merely "Black Channels" as illustrated in figure 22.

F-messages between an F-host (safety control) and its F-device are transported as payload in PROFINET frames. The PROFIsafe protocol spares users from having to conduct the safety assessment of their individual backplane bus system and other channels beyond PROFINET. It thus guarantees the functional safety of the complete path, from the sender of an F-signal (e.g., F-module in a remote bus terminal) to the receiver (F-host) and vice versa. This is achieved through additional safety measures of the F-messages.

The measures include: consecutive numbering of F-messages ("Sign-of-life"), a time expectation with acknowledgment ("Watchdog"), an identifier between sender and receiver ("F-address"), and a data integrity check (CRC = cyclic redundancy check).

7.2.3 What has to be considered for the implementation?

Senders and receivers of F-messages operate in layers above the "Black Channel". The PROFIsafe-layers are implemented as software ("Driver"). The centerpiece of the PROFIsafe-layer is a state machine for periodic cyclic processing of the F-messages and for rarer operations, such as system start, switch-on/switch-off, CRC error handling, etc. Figure 23 shows how the PROFIsafe-layer interacts with the individual F-device technology and the F-host user program.

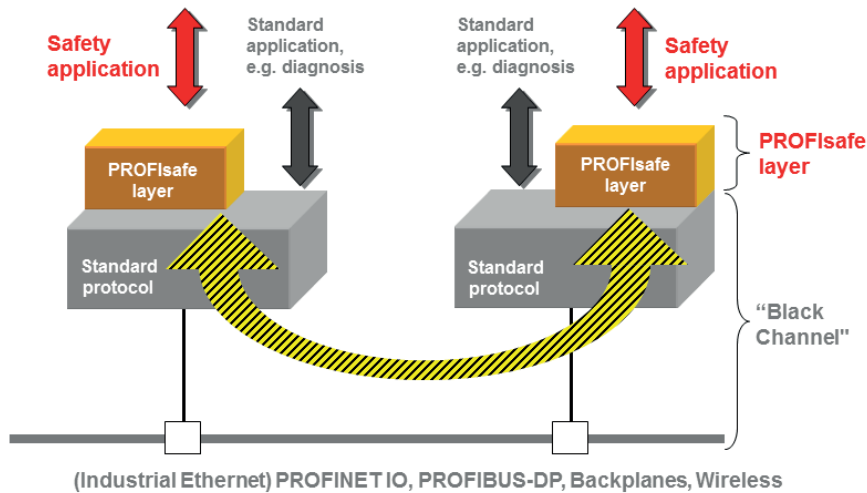

Fig. 22: "Black Channel" principle

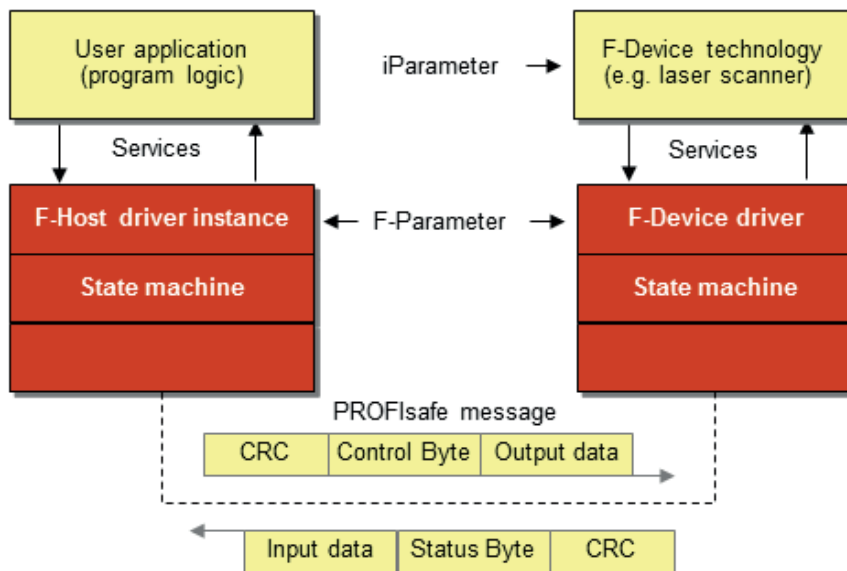

Fig. 23: PROFIsafe-layers in F-host and F-device

As a first step for implementation, becoming familiar with the basic safety standard IEC 61508, or seeking corresponding professional advice is recommended. The following applies generally: implementation of PROFIsafe does not turn a standard device into an F-device. The architecture of the "technology", the protocol, and the way both are implemented determine the Safety Integrity Level (SIL) of the device that is achieved.

7.2.4 Where is implementation support available?

There are two options for implementing the PROFIsafe driver software. Development of the software according to the specification or use of a development kit available on the market. The advantages of development kits are obvious: tested

driver software, additional valuable information, tools, and technical support.

Some support providers are listed in the competency matrix of the brochure "PROFINET Technology - The Easy Way to PROFINET" (www.profibus.com/pntb).

7.2.5 Safety assessment

It should be noted that the PI test labs perform the PROFIsafe-layer tests on behalf of testing bodies accredited according to ISO 17025. These are, for example: TÜV (worldwide), INRS (France), IFA (Germany), SP (Sweden), SUVA (Switzerland), HSE (Great Britain), FM (USA).

These are the only approved bodies that may perform a safety assessment according to IEC 61508.

7.3 PROFIdrive

7.3.1 Which drives does PROFIdrive use?

The PROFIdrive application profile, as a supplement to the PROFINET interface, offers users an interoperable application interface and thus the possibility to operate drive devices of various manufacturers with one control application.

The PROFIdrive profile defines different types of drive interfaces to cover the respective requirements of the different drive applications in automation. The various interface types are designated as "application classes" in the PROFIdrive profile.

Because drives frequently have Drive Based Functional Safety functions, the PROFIdrive profile also offers an interoperable interface for the control of safety functions.

The following PI documents provide more detailed information about PROFIdrive:

- PROFIdrive System Description
www.profibus.com/pdsd
- PROFIdrive White Paper
www.profibus.com/pdwp

7.3.2 How is implementation carried out?

The PROFIdrive interface is implemented as a software-layer between the PROFINET interface of the device and the device-internal drive control interface (see figure 25).

For drives of application class 4, a PROFINET IRT interface is needed. In addition to the PROFIdrive-layer functions of application classes 1 and 3, the implementation of isochronous control (via the "sync" interface in the figure 25) is required.

7.3.3 Where is implementation support available?

Freeware as well as professional products and support are available for implementing PROFIdrive in the drive device. A constantly updated overview can be found in "PROFIdrive - Implementation". (www.profibus.com/pdi).

PI offers free one-day workshops "PROFIdrive and ENCODER" in Germany. This workshop provides in-depth knowledge of PROFIdrive technology for users and device builders as well as implementation information for device builders. The upcoming German workshop schedule can be found under "PROFIdrive Workshop" (www.profibus.com/Workshops).

The following specifications for PROFIdrive are provided by PI:

- PROFIdrive - Profile Drive Technology
www.profibus.com/pdpdt
- Amendment PROFIdrive on PROFIsafe (PoP)
www.profibus.com/pdpdt
- Test specification for PROFIdrive Profile Certification
www.profibus.com/pdts

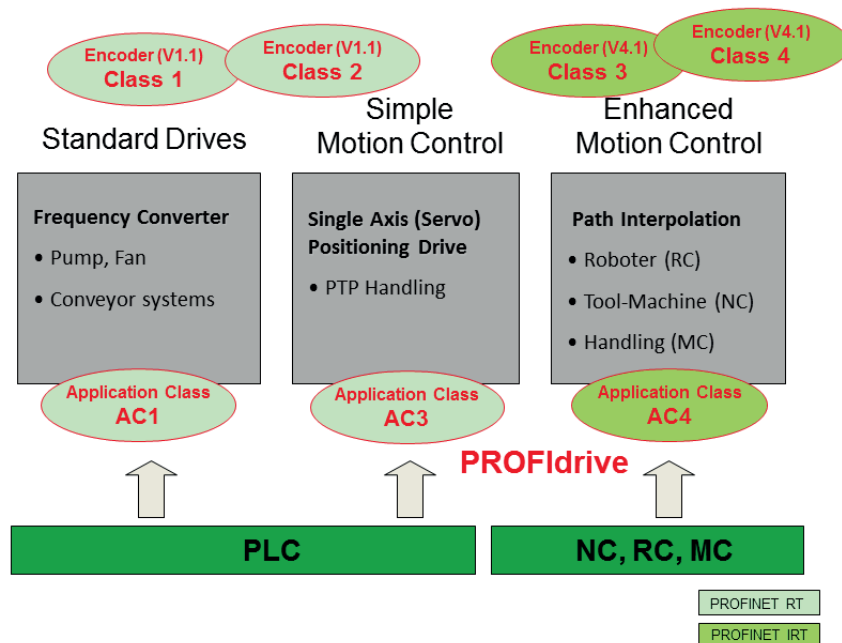

Fig. 24: PROFIdrive and Encoder application classes

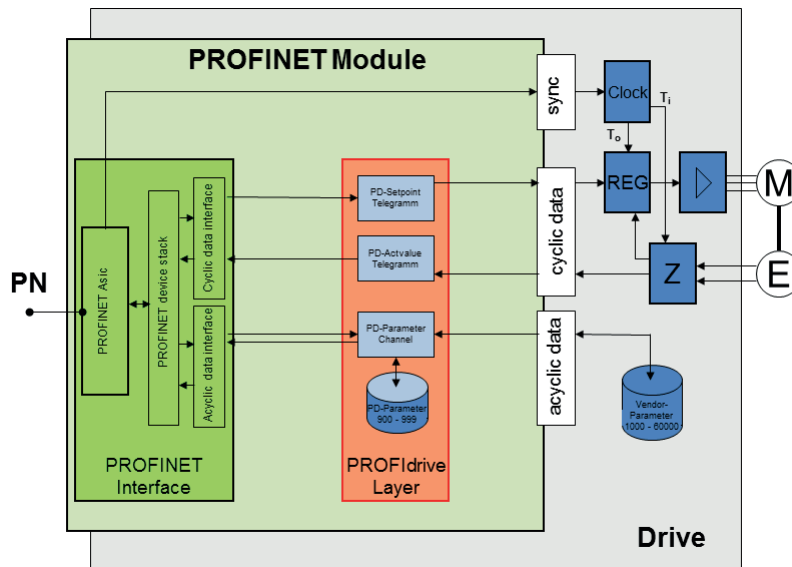

Fig. 25: PROFdrive interface

The members of the PI marketing PROFdrive & Encoder Working Group are conducting the "PROFdrive Community Project", which makes information and source code for implementation of PROFdrive devices available to all device builders as freeware (www.profibus.com/pdcph).

Some companies that offer PROFINET communication technology also offer an adapted PROFdrive-layer as a supplement to your PROFINET solution. An overview of this is contained in "Your Way to PROFdrive" (www.profibus.com/pdcp).

You can also contact the PI PROFdrive Competence Center for questions regarding PROFdrive (www.profibus.com/PICC).

7.4 ENCODER profile

7.4.1 Which encoders use the ENCODER profile?

The ENCODER profile defines different types of encoder interfaces to cover the respective requirements of the different motion applications in automation. The various interface types are designated as "classes" in the ENCODER profile. More detailed information about the ENCODER profile can be found in the "PROFdrive White Paper" (www.profibus.com/pdwp).

7.4.2 How is implementation carried out?

The ENCODER profile interface is implemented as a software-layer between the PROFINET interface of the device and the device-internal position sensing unit (see figure 25 "PROFdrive interface" in the *PROFdrive* section).

For encoders that require a PROFINET IRT interface, isochronous control of the position sensing (via the "sync" interface in figure 25) must also be implemented.

Freeware as well as professional products and support are available for implementing ENCODER profile in the encoder device. A constantly updated overview can be found in "PROFdrive - Implementation" (www.profibus.com/pdi).

7.5 PROFenergy

Nowadays, production plants exhibit high energy consumption - even during pauses. This is the focus of PROFenergy. Using PROFenergy, consumers not required during pauses can be simply and reliably switched to optimized energy saving modes. In addition, it is possible to transfer current energy measurements for an energy management system.

The PI home page offers comprehensive information about PROFenergy at: www.profibus.com/technology/profenergy.

You can find explanatory videos on PROFenergy at: www.profibus.com/peyt.

7.5.1 How does PROFlenergy function?

The PROFlenergy profile specifies commands that the controller uses to communicate upcoming pauses to PROFINET field devices. The commands are transferred using acyclic PROFINET services (Read Record/Write Record). After receipt of the commands, the relevant devices and system components are brought to standby state by the firmware of the device according to their technological characteristics. This process is reversed at the end of pauses.

Figure 26 presents an overview of the PROFlenergy commands.

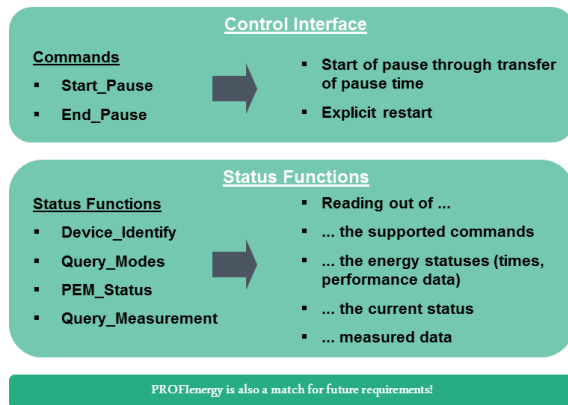

Fig. 26: PROFlenergy commands

Furthermore, PROFlenergy allows consumption data, such as electrical power or the energy meter value, to be read out from devices in a uniform format. During operation, this information is recorded and displayed on an HMI device, for example.

7.5.2 What must be considered for the field device implementation?

The firmware of PROFINET field devices must process the PROFlenergy commands and make them available to the application.

In PC-based systems, the Wake-On-LAN of a standard Ethernet controller is integrated in PROFlenergy.

8 Stacks / Modules / Implementation

8.1 General

In principle, a device can also be connected to PROFINET via its existing interfaces and a gateway. In addition, there are gateways with user-configurable interfaces for adaptation to device-specific

protocols. Because the gateway solution does not normally require any device modification, it is not further examined in this section.

For direct connection of devices, implementation of a PROFINET interface is needed, which can be realized either with insertable modules or through direct implementation of ASICs or FPGAs and software. The free downloadable brochure "PROFINET Technology - The Easy Way to PROFINET", presents the options comprehensively, and lists some technology support companies (www.profibus.com/pntb).

For this reason, only an overview of the implementation options is given in this section.

8.2 Technology Workshops

PNO conducts free one-day Technology Workshops on a regular basis. For a schedule of workshops in Germany, go to: www.profibus.com/Workshops.

The goal of the workshop is to inform interested companies about available options for developing PROFINET products. By attending the workshop, field device manufacturers save the time it would take to familiarize themselves. In addition, some of the leading technology companies provide development support and give practical tips for implementation and testing as part of a micro-fair.

8.3 What benefits do modules offer?

Small insertable modules with manufacturer-specific or standardized interfaces to the application allow fast integration of a PROFINET connection because all communication tasks are handled by the module. The device manufacturer does not have to deal with the communication details and can instead concentrate on the application in the device. This solution is especially attractive for small quantities or when little development time is available. The modules have ready-made GSDs that enable fast adaptation to the PROFINET field device.

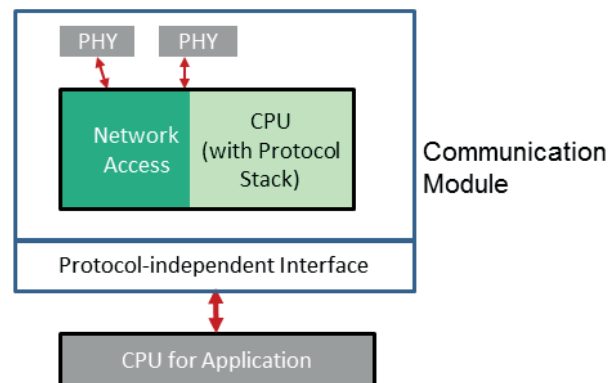

Fig. 27: Field device with communication module

Note: The device must be certified even when a module is used. It is not possible to "inherit" certificates.

8.4 Embedded solutions

8.4.1 Software solution with standard microcontroller

For the interaction between the Ethernet controller and the application, a software stack that processes the communication tasks and provides an interface to the application is always needed. In the simplest case this protocol stack is processed by a standard microcontroller in the PROFINET field device. For this, technology suppliers offer various development packages and evaluation boards for specific processor types and operating systems. Because all communication tasks rely on software solutions, the performance of this solution is limited and is better suited for devices that have low requirements for reaction times.

This solution is not possible for PROFINET field devices with IRT because specific ASICs or FPGAs are required for that.

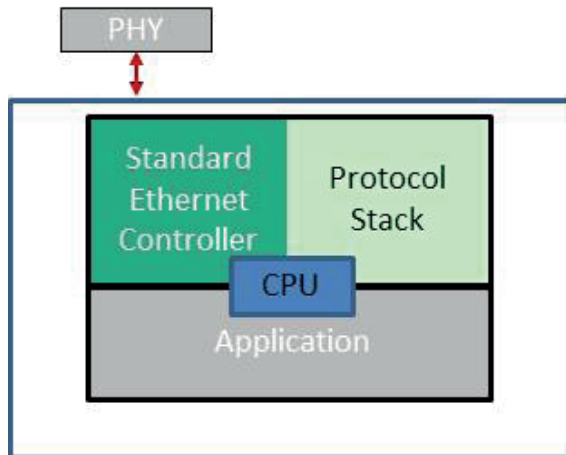

Fig. 28: Field device with software solution

8.4.2 When are ASIC solutions of interest?

ASICs process time-critical functions of the PROFINET protocol in hardware, and are therefore much faster than pure software solutions. In addition, most ASICs have a switch and the associated PHYs integrated. As a result, the PROFINET field device can be integrated into systems more easily and cost-effectively. Because the ASICs are usually designed as a system on chip, they contain standard embedded controllers that are suitable for processing the protocol stack and the application. Many of the offered ASICs contain the hardware support needed for IRT.

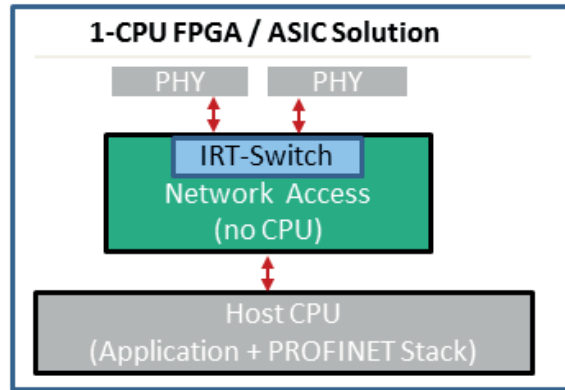

Fig. 29: Field device with host CPU and simple ASIC/FPGA, application, and PROFINET stack on host CPU

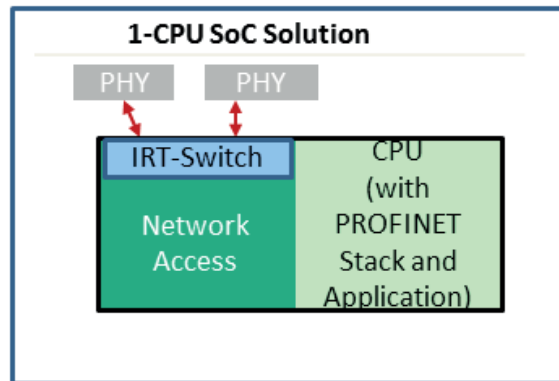

Fig. 30: Field device without host CPU with ASIC (SoC), application, and PROFINET stack on ASIC CPU

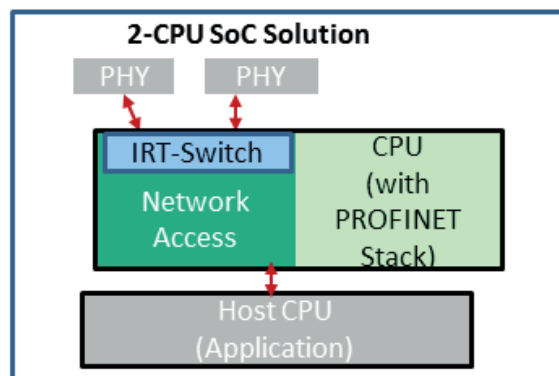

Fig. 31: Field device with host CPU and ASIC (SoC), PROFINET stack on ASIC CPU, and application on host CPU

The ASIC solutions are suitable for high-performance devices and high quantities because cost-optimized hardware can be developed with them. For implementation, companies offer development

packages that contain all required hardware and software components, such as evaluation boards, protocol stacks, examples, testing capabilities, etc.

8.5 Which advantages do FPGAs offer?

Like ASICs, FPGAs provide hardware support for time-critical tasks. In contrast to the ASIC, the FPGA is more flexible because its function can be changed by the developer and the developer's own functionalities can be incorporated in the FPGA in addition to the PROFINET function. The disadvantage of FPGAs is their higher costs especially if the increased flexibility is not needed.

In this case too, there are various complete offers in the form of development packages that enable implementation in the PROFINET field device.

9 Certification

9.1 Is certification required for PROFINET?

Yes, a PROFINET field device must be certified. If you market your field device with a PROFINET connection, it must have a PROFINET certificate. This assures device manufacturers and end customers that the field device will communicate in conformance with the standard in a PROFINET system, and also guarantees interoperability between the PROFINET field devices of different manufacturers. Please bear in mind that the cost to fix errors is generally higher the later a problem is detected. The subsequent costs of a communication problem in an automation system are usually many times higher than the costs of certification.

9.2 General procedure for obtaining a certificate

1. In a timely manner during the development phase, make an appointment for your certification test at a PI-accredited test lab (PITL) of your choice. Keep in mind that a test date may need to be requested a few weeks or months in advance based on the PITL workload. Contact the PITL in a timely manner and inquire about the current time frame. The PITL can also answer your questions about certification costs. A list of the approved PITLs can be found at the following link: www.profibus.com/test-labs

2. Every PROFINET device has a VendorID and DeviceID, which are stored in the GSD file as well as on the device itself. You can request a VendorID from PI. The VendorID is valid for all PROFINET devices of a manufacturer (see also *Section 2*).
3. Creation of the GSD file during the implementation phase.
Note: Think about how you will describe your PROFINET device model in the GSD file at an early stage. The PI Competence Centers (PICCs) are available to help you with any questions.
4. On the scheduled certificate date, you provide a series device and the associated GSD file. Any additional equipment and documentation needed for putting the device into operation during the certification test must also be provided. After the test is complete, the test lab creates a test report and delivers it to the device manufacturer as PDF file.
5. The device manufacturer can use the test report of the PITL to request a PROFINET certificate. Therefore send the test report and a filled application form via e-mail to certification@profibus.com (www.profibus.com/apc).

9.3 What does the manufacturer have to clarify or create for a certification?

- A PROFINET device must always be provided together with the associated GSD file for certification.
- Every PROFINET device has a VendorID and DeviceID, which are stored in the GSD file as well as on the device itself. You make a one-time request to PI for a VendorID. It is valid for all PROFINET devices of the manufacturer. As the device manufacturer, you assign the DeviceID. In doing so, you ensure that the combination of VendorID and DeviceID is unique worldwide so that it describes exactly one PROFINET device with its GSD file.
- In the test application, the device manufacturer specifies which DAP (Device Access Point) in the GSD file is to be tested (if the GSD contains multiple DAPs). A DAP is the part of a field device that contains the bus connection and the user program. Generally, only one DAP from the GSD file will be tested, and this DAP is noted in the test report. A brief description of the DAP can be found in the *"PROFINET System Description, Section 2.2, Device model of a device"*.

- Specify the conformance class (A, B, or C) that the device is to achieve. Depending on the conformance class entered in the GSD, additional certification tests will be performed (e.g. test of isochronism for Conformance Class C). For a brief description of the conformance classes, see *"PROFINET System Description, Section 1.1, Conformance Classes"*.
- Optionally, an application class can be specified in the GSD file. Certain minimum functionalities for the use case are assigned by definition to an application class. Based on the entered application class, the test lab then tests whether the device correctly provides all functionalities assigned to this application class. See also *Section 6*.
- A network load test (Security Level 1 Test) is also required as part of the certification test. The device manufacturer specifies the network load class (1, 2, or 3) for which the device is to be tested. Network load class 1 has the lowest requirements. Network load class 3 has the highest requirements. More information about the network load test can be found in the document "Guideline PROFINET IO Network Load", which is a component of the PROFINET test bundle available to PI members for free download from the PI website. The link to this document is: www.profibus.com/pniotb
- The manufacturer must ensure compliance with the relevant national and international regulations.
- For testing according to Conformance Class C, a synchronization pin must be accessible for the certification test to allow testing of the isochronism of the device, e.g., with an oscilloscope. This pin must be taken into consideration when designing the device. This pin is no longer needed for subsequent series devices because it is required only for certification.

9.4 Can I reuse the certificate of the technology provider?

No, that is not possible. When pre-certified technologies are used you, as the device manufacturer, do not have to become familiar with all details of the PROFINET standard. This significantly reduces the risk that errors will occur during the tests.

A PROFINET certification test is always the test of a complete device, consisting of the PROFINET protocol unit (e.g., hardware + protocol stack +

GSD) and the application. This is necessary because the interaction between the application and the PROFINET protocol unit (control of the PROFINET user interface by the application) can affect the execution of the PROFINET protocol. The aim is for PROFINET communication problems resulting from incorrect behavior of the application or protocol unit to be excluded as a result of the certification test.

9.5 References

Additional information about certification can be found in the document "How to get a certificate for a PROFINET Device", which members can download from the PI website at:

www.profibus.com/pncp

10 Life Cycle of the PROFINET field device

The life cycle of a PROFINET field device is influenced by new firmware versions and hardware and software extensions. This can affect the version numbers of the device, the compatibility with earlier product versions, and the data-related description in the GSD file.

10.1 Version numbers of the PROFINET field device

PROFINET defines that a PROFINET module has a software version number.

Typically, the PROFINET technology provider also versions its technology (firmware, software protocol stack, etc.). The device manufacturer must disengage itself from the numbering of the technology provider. Otherwise, the first release of a new module would have to be assigned the version number of the technology, e.g., V 4.2.

The version number of a module is fixed in the firmware and can be read out from the module in various ways (e.g., I&M, SNMP). In addition, the version number can often also be read on the outside of the module housing.

During the certification test of the module, a check is made to determine whether the printed version number matches the number read out on the bus. Moreover, consistency between the read out version number and the GSD file is also checked.

In the case of a firmware update, the new firmware must also receive a new version number. It is up to the manufacturer to decide how this number is assigned, e.g., which digit is incremented.

A generic number (V1) can also be specified in the GSD file while the module itself uses a decimal place in the firmware (V1.0).

10.2 How do further developments of the field device influence the GSD file?

This section provides additional information regarding maintenance of the GSD file and supplements the description in *Section 6*.

A PROFINET GSD file describes all devices of the device family that share the same DeviceID. Therefore, there is typically more than one device that is described in the GSD file. For example, a device family can have one head station with Ethernet version "Copper" and one with "POF". Both devices possibly use identical IO submodules and differ otherwise only in the Ethernet version.

A device family of compact devices with different IO versions is another example. One device has 16 bits digital input, a second device has 16 bits digital output, and another device has 8 bits digital input and 8 bits digital output. All of these individual devices are described in the same GSD file.

10.2.1 Scenario "New hardware variant: head station"

Let's assume that a module is initially marketed with Ethernet version "Copper". If the module catches on, it is possible that customers of the module will ask for this module with a "POF" interface. To meet this request, a new hardware variant must be developed to start with. Minor software changes may also be necessary in parallel (depending on the PROFINET base technology used). However, a new stand-alone GSD file is not created for this new module. Instead, the existing file is expanded to include a new Device Access Point (DAP). In doing so, it must be ensured that the existing DAP is not modified.

Updating to this new GSDML file in existing engineering projects is then possible without triggering compatibility problems. At the same time, the new module can be used during engineering.

10.2.2 Scenario "new software with new PROFINET features for existing hardware"

Let's assume that an existing module with existing hardware is to be expanded via software update to include a new PROFINET feature (e.g., shared device). For sake of simplicity, this example assumes that the new software is "V2" and the existing software is "V1".

In this case, a new DAP (for V2) must be added to the GSD file. Under no circumstances is it permitted to simply expand the DAP "V1" in the existing GSD file to include the "shared device" feature. Otherwise, it is just a matter of time until compatibility problems occur in the field.

The application of this new software "V2" can now be written in such a way that it knows the module and submodule identifiers as well as the behavior of the software "V1". If this is implemented correctly, the software "V2" can provide exactly the same functions that "V1" provided. If a module with "V1" is now replaced in the field by a spare part module with "V2", the PLC will detect the difference, but the difference will have no consequences. The software "V2" substitutes the software "V1", so to speak.

10.3 What should be considered for the delivery state of the field device?

An out-of-the-box PROFINET module must have the following PROFINET settings:

- No set NameOfStation (empty string "", length 0)
- No set IP address (0.0.0.0)
- No stored PDEV parameters
- Empty data records for I&M 1 to 3

11 Product marketing

11.1 The product catalog of PI

The PNO and the PI Organization provide a product catalog for marketing of devices:
www.profinet.com/ProductFinder.

Every certified device of a member company is to be entered in the product catalog of PI via input mask or Excel upload and should be updated regularly. The corresponding access data, if not available, can be requested at PI Support Center. If desired, the entry in the product catalog will be done by the office when issuing a new certificate.

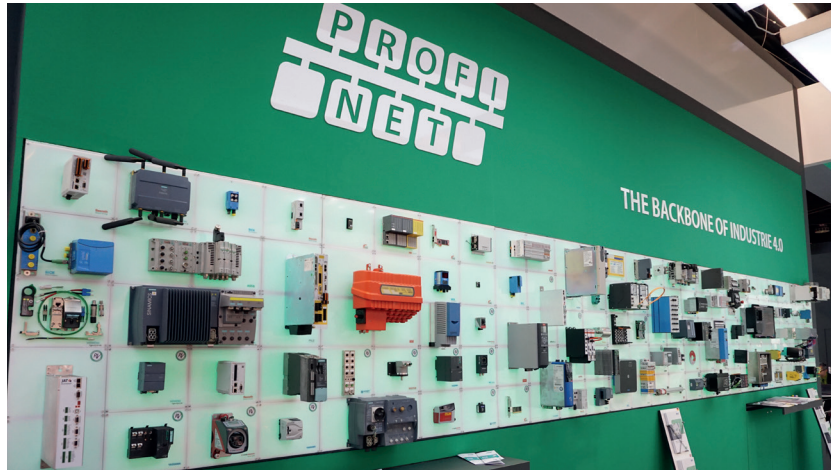

Fig. 32: Multi-vendor wall of PI at trade fairs



Fig. 33: Individual company presentations at PI trade fair booth

11.2 Presentation of field devices at trade fairs

Take advantage of the multi-vendor wall to present your device at SPC IPC Drives Nuremberg, Hanover Fair, embedded world in Nuremberg, or other local trade fairs. The device (not functional) will be presented to a large audience on an LED-backlit wall at attractive positions in the trade fair.

On the current state in 2018, an initial exhibit after certification is free of charge. For additional exhibits, see marketing program of the PNO or regional RPA.

Separate tilted panels are available for individual company presentations.

11.3 Advertising of field devices in PROFINEWS

PROFINEWS: www.profinews.com

Your product can also be presented in the PI newsletter. A parallel presentation is also included in the similarly designed PROFINEWS app (for iOS and Android).

11.4 Marketing working groups

Member companies can directly influence marketing activities as well as the approval of requirements by participating in the Marketing Working Group of the PNO. Active participation and good ideas are always welcome.

Contact information for the WG is available on the PI web page: www.profibus.com/WorkingGroup

12 Glossary

Abbreviations used in this document:

AIDA	Automation Initiative of German Domestic Automobile Manufacturers
AMR	Asset Management Record
ASIC	Application-Specific Integrated Circuit
CC	Conformance Class
DAP	Device Access Point
EMC	Electromagnetic Compatibility
EMI	Electromagnetic Interference
F	Fail-Safe
FOC	Fiber-Optic Cable
FPGA	Field-Programmable Gate Array
FW	Firmware
GSD	General Station Description
GSDML	GSD Markup Language
gPTP	Generalized Precision Time Protocol
HW	Hardware
IEC	International Electrotechnical Commission
IEEE	Institute of Electrical and Electronics Engineers
IO controller	Controller in which the automation program runs
IO device	Distributed field device
IP-Codes	International Protection Codes
IP20	Protected against solid foreign objects with diameter ≥ 12.5 mm
IP65	Protected from dust and water jets
IP67	Protected from dust and temporary immersion
IRT	Isochronous Real-Time
I&M	Identification and Maintenance
LED	Light-Emitting Diode
MAC	Media Access Control
M12	Circular connector with metric thread
NAMUR	Standards development organization for instrumentation and controls in the chemical industry, since 2005 "User Association of Automation Technology in Process Industries"
PAC	Programmable Automation Controller
PC	Personal Computer
PDEV	Physical Device
PI	PROFIBUS & PROFINET International
PICC	PI Competence Center
PITL	PI Test Lab
PLC	Programmable Logic Controller
PNO	PROFIBUS Nutzerorganisation e.V. (www.profibus.de)
POF	Polymer Optical Fibers
RJ	Registered Jack (standardized socket)
RJ45	Standardized connector for Ethernet
RPA	Regional PI Association
SCRJ	Connector for FOC transmission

SIL	Safety Integrity Level
SNMP	Simple Network Management Protocol
SoC	System-on-Chip
SoE	Sequence of Events
TAI	International Atomic Time (TAI stands for French Temps Atomique International)
TI	At time TI, all participants in IRT must save their inputs
TO	At time TO, all participants in IRT must write their outputs
WG	Working Group
XML	Extensible Markup Language

13 References

This Guideline references the following listed PI documents, which are available for download via the PI website. Please use the order form to order the information material from PI: www.profibus.com/OrderForm.

PROFINET Technology - The Easy Way to PROFINET, Order No.: 4.272

www.profibus.com/pntb

PROFINET Technology and Application - System Description, Order No.: 4.131 (dt.) / 4.132

www.profibus.com/pnsd

Fieldbus integration in PROFINET IO, Order No: 7.012

www.profibus.com/fbipn

Conformance Classes, Order No.: 7.042

www.profibus.com/pncc

Cabling and Interconnection Technology Guideline for PROFINET, Order No.: 2.252

www.profibus.com/pncit

PROFINET Installation Guidelines, Order No.: 8.072

www.profibus.com/pnig

PROFINET Commissioning Guideline, Order No. 8.082

www.profibus.com/pnig

GSDML Specification, Order No.: 2.352

www.profibus.com/GSDML

How to get a certificate for a PROFINET Device, Order No.: 2.922

www.profibus.com/pncp

PROFIsafe Policy, Order No.: 2.282

www.profibus.com/psp

PROFIsafe Technology and Application - System Description, Order No.: 4.342

www.profibus.com/pssd

PROFIdrive Technology and Application - System Description, Order No.: 4.322

www.profibus.com/pdsd

PI White Paper Drive Technology with PROFINET

www.profibus.com/pdwp

Your Way to PROFIdrive

www.profibus.com/pdi

PROFIdrive - Profile Drive Technology, Order No.: 3.172

www.profibus.com/pdpdt

Amendment PROFIdrive on PROFIsafe, Order No.: 3.272

www.profibus.com/pdpdt

Test Specification for PROFIdrive Profile V4.1, Order No.: 2.382

www.profibus.com/pdts

PI White Paper: The PROFInergy Profile

www.profibus.com/pewp

Place for notes

PROFINET Field Devices

Recommendations for Design and Implementation

Version April 2018

Order No.: 8.202

Publisher

PROFIBUS Nutzerorganisation e.V. (PNO)
PROFIBUS & PROFINET International (PI)
Haid-und-Neu-Str. 7 • 76131 Karlsruhe • Germany
Phone: +49 721 96 58 590 • Fax: +49 721 96 58 589
E-Mail: info@profibus.com
www.profibus.com • www.profinet.com

Exclusion of liability

Although the PROFIBUS Nutzerorganisation e.V. (PNO) has taken the most care in compiling the information contained in this brochure, it cannot guarantee that the content is completely error-free, and the PROFIBUS Nutzerorganisation e.V. (PNO) can assume no liability, regardless of the legal basis for any potential claims. The information in this brochure is reviewed on a regular basis. Any necessary corrections will be made in subsequent editions. We would be grateful for any suggestions as to how the content could be improved.

Any designations that appear in this brochure could potentially constitute trademarks. Any use of such trademarks by third parties for their own ends risks infringing the rights of the proprietors concerned.

This brochure is not intended to serve as a substitute for the relevant IEC standards, such as IEC 61158 and IEC 61784, or the relevant specifications and guidelines of PROFIBUS & PROFINET International. In case of doubt, these standards, specifications, and guidelines are authoritative.

© Copyright by PROFIBUS Nutzerorganisation e.V. (PNO) 2018. All rights reserved.



More Information:
www.profibus.com/pni



PROFIBUS Nutzerorganisation e. V. (PNO)
PROFIBUS & PROFINET International (PI)
Haid-und-Neu-Str. 7 · 76131 Karlsruhe · Germany
Phone: +49 721 96 58 590 · Fax: +49 721 96 58 589
E-Mail: info@profibus.com
www.profibus.com · www.profinet.com